

2020 | Edition 02

concrete

Price & Specification Guide

£ Sterling | € Euro | \$ Dollar

WHAT WE DO

connection

“We design and manufacture innovative commercial furniture that adapts to the ever-changing ways in which people effectively work and learn. Allowing you to create space that works harder, smarter and altogether better”

After all, we know that space is a critical asset. The way it's defined influences physical and emotional attitude, creates culture and affects the productivity of those within it. Exactly why we build this philosophy into all of our thinking and all of our products.

Our insight into the needs of modern commercial, educational and public-sector environments gives us an understanding of their evolving working practices. We've identified these as Collaborating, Focusing, Meeting and Socialising. These four cornerstones interpret how people work together, seek sanctuary, access technology and share ideas. And by understanding how people work, we can create the space that works around them.

Take a look through our portfolio and you'll find a collection of dynamic furniture solutions that are agile, intuitive and support the working practices for all sorts of environments from complex office settings to large-scale education projects and everything in between. We love what we do and we love a challenge, so if you need help creating a more effective and productive workspace – a space that works, get in touch.

Design
Manufacture
Deliver

Head Office & Showroom

Dogley Mills,
Penistone Road,
Huddersfield,
West Yorkshire,
HD8 0LE

T: 01484 600 100
enquiries@connection.uk.com

London Showroom

31 Great Sutton Street,
Clerkenwell,
London,
E1CV 0NA

T: 020 7253 9877

Manchester Showroom

The Old Law Library,
14 Kennedy Street,
Manchester,
M2 4BY

T: 01484 600 100



@Connectiontweet
Connection Furniture
@connectionseatingltd
@Connectionseating
@Connectionpin
Connection Seating

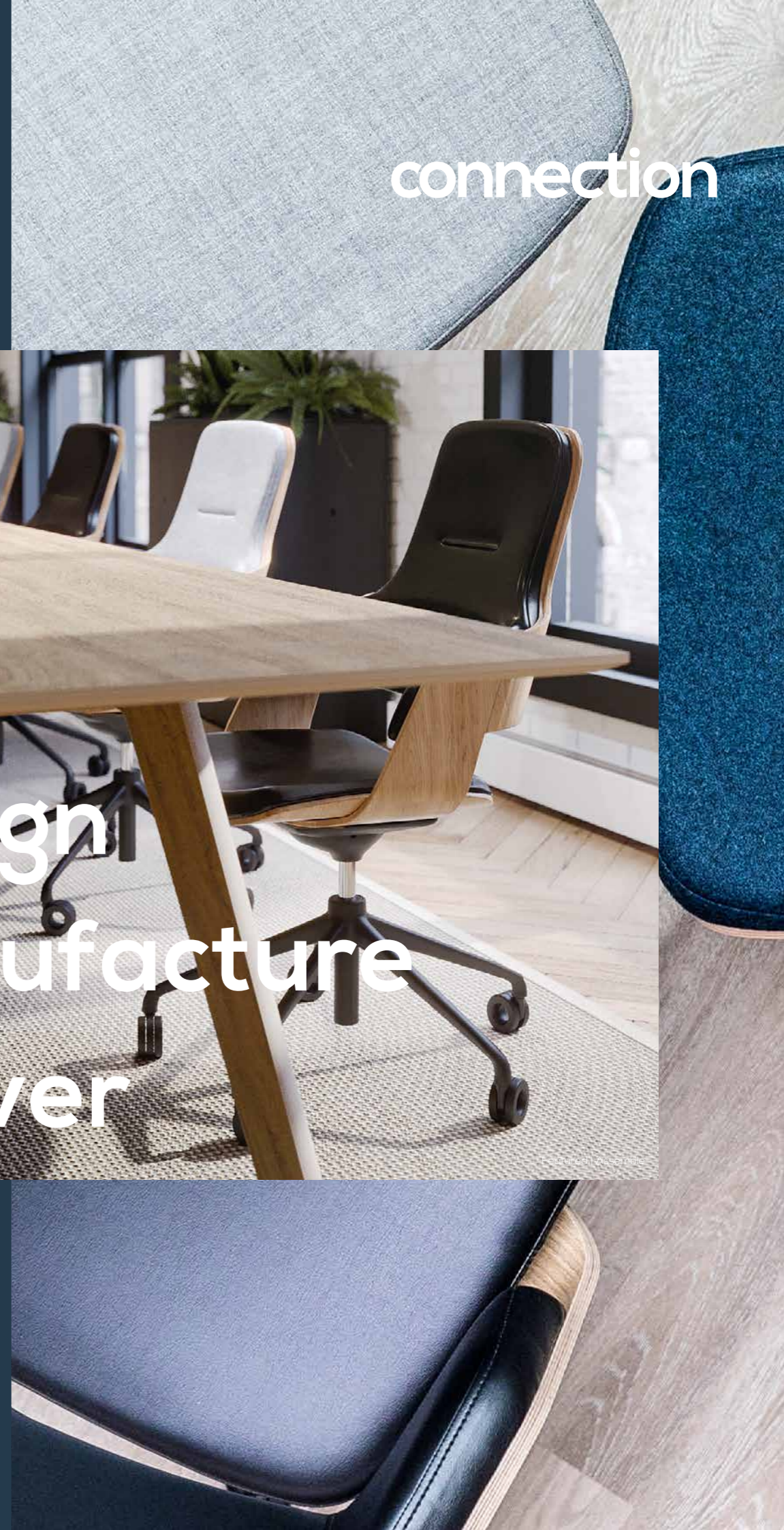

Contents

Contents

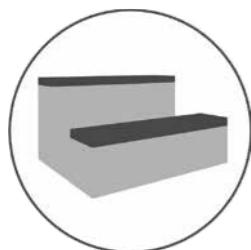

Collaborative

Soft Seating

Tables

Rooms	pg 8
Platforms	pg 15
Platforms Additions	pg 19
Platforms Accessories	pg 25
Tier	pg 29

Hygge	pg 70
Muse	pg 74
Dixi	pg 76
Mae	pg 79
Ark	pg 82
Kala	pg 83
Pear	pg 86
Rollie	pg 87
Korus	pg 90
Swoosh Chairs	pg 93
Check	pg 97
Leo	pg 100
Mortimer	pg 102
Tryst Sofas	pg 105
Swoosh Sofas	pg 110
Horizon	pg 112

Centro	pg 117
Centro Rustic	pg 120
Centro Lite	pg 121
Beam	pg 124
Co.Table	pg 129
Tubes	pg 135
Connect	pg 140
Omni	pg 142
Dixi	pg 142
Gloss	pg 143
Check	pg 146
Leo	pg 146
Mortimer	pg 146
Flow	pg 148
Fusion	pg 150





Booths

Tryst	pg 35
Crux	pg 41
Nomad	pg 44
Soloscape	pg 46
Flock	pg 50
Hive	pg 55
Peacework	pg 61
Cubbi	pg 63



Work-Café Chairs

Xpresso 	pg 153
Session	pg 160
Luna	pg 162
Laurel	pg 164
Canova 	pg 166
Centro Chairs	pg 168
Tubes Chairs	pg 169







Stools & Benches

Centro Stools & Benches	pg 174
Tubes Stools & Benches	pg 176
Swoosh Stools	pg 180
Platforms Box	pg 182
Cubix	pg 184



Work Chairs

Assemble	pg 188
Muzia 	pg 190
Compito 	pg 192
Gravity 	pg 194
Is	pg 195
My	pg 196
Report 	pg 198

 = Quick Ship

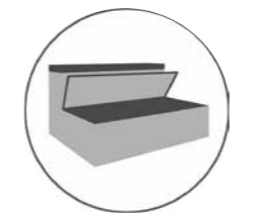

Product Specification

Hive Modular Specification	pg 200
Flock Modular Specification	pg 219
Horizon Modular Specification	pg 226
Tier Modular Specification	pg 230



Material, Fabric & Power

Material Specification	pg 231
Table Top Finishes	pg 232
Fabric Specification	pg 233
Power Specification	pg 235



Resources

Ordering Guidelines	pg 241
Delivery & Returns	pg 242
Guarantee	pg 243
CSR, Sustainability & the Environment	pg 244
Export Information	pg 245
A-Z Index	pg 247

Rooms

Meeting room



Rooms

Collaborate room with Centro Lite table & Swoosh stools



Collaborative

Rooms Example Configurations

Collaborate Room

Description: 3.0m x 3.0m 4 post structure with oak veneer cladding, lights and acoustic baffles. 2 whiteboard walls, 1 upholstered media wall



Price £ € \$
 £16,364 €18,223 \$22,185

Please note: Price refers to the Rooms product only.

Learning Room

Description: 3.0m x 3.0m 4 post structure with oak veneer cladding, lights and acoustic baffles. 2 acoustic walls, 1 whiteboard wall



Price £ € \$
 £19,590 €21,666 \$26,377

Please note: Price refers to the Rooms product only.

Meeting Room

Description: 3.0m x 3.0m 4 post structure with oak veneer cladding, lights and acoustic baffles. 1 acoustic wall, 1 upholstered media wall, 1 whiteboard wall



Price £ € \$
 £18,366 €20,437 \$24,880

Please note: Price refers to the Rooms product only.

Social Room

Description: 3.0m x 3.0m 4 post structure with oak veneer cladding, lights and acoustic baffles. 2 venetian trellis walls, 1 woodland trellis wall, 1 curtain wall.



Price £ € \$
 £15,673 €17,450 \$21,237

Please note: Price refers to the Rooms product only.

Adjoining Room

Description: 3.0x4.0m with adjoining 3.0x2.4m 6 post structure with oak veneer cladding, lights, straight ceiling baffles, whiteboard walls, Venetian trellis walls, upholstered media walls & curtain



Price refers to the following Rooms options only: Rooms aluminium profiles, oak veneer birch plywood cladding, 2 mid light beams, 10 light fittings, adjoining leg, 2 straight ceiling baffles, 2 power modules (A), curtain, 2 upholstered media walls, 1 Venetian birch trellis wall, 2 whiteboard walls

Price £ € \$
 £33,733 €37,577 \$45,744

Adjoining Meeting Room

Description: 3.0x3.0m with adjoining 3.0x4.0m 6 post structure with oak cladding, lights, straight ceiling baffles, acoustic wall, glass wall & door, upholstered media walls & whiteboard walls



Price refers to the following Rooms options only: Rooms aluminium profiles, oak veneer plywood cladding, 2 mid light beams, 11 light fittings, adjoining leg, 2 straight ceiling baffles, 1 power module (A), 1 acoustic walls, 1 glass wall with door, 2 upholstered media walls, 2 whiteboard walls

Price £ € \$
 £39,108 €43,535 \$52,992

Rooms Base Structure

Rooms: 4 post wooden base structure with cladding & lights
Choose your size:

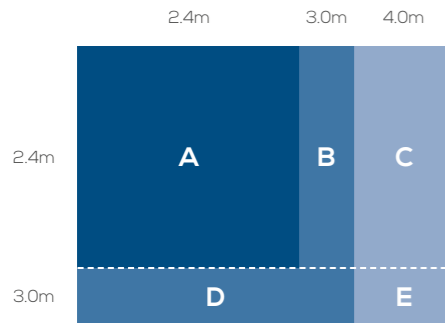

Rooms	No Baffles			Acoustic Baffles*		
	£	€	\$	£	€	\$
A 2.4x2.4m	£5,619	€6,215	\$7,565	£7,493	€8,287	\$10,088
B 2.4x3.0m	£6,008	€6,644	\$8,089	£8,525	€9,427	\$11,477
C 2.4x4.0m	£6,237	€6,897	\$8,397	£9,842	€10,884	\$13,250
D 3.0x3.0m	£6,303	€6,971	\$8,486	£9,484	€10,488	\$12,767
E 3.0x4.0m	£6,619	€7,320	\$8,912	£10,821	€11,967	\$14,568

Adjoining Rooms: Additional Rooms with wooden cladding & lights can be linked together & share an adjoining wall
Price refers to the additional adjoining room only

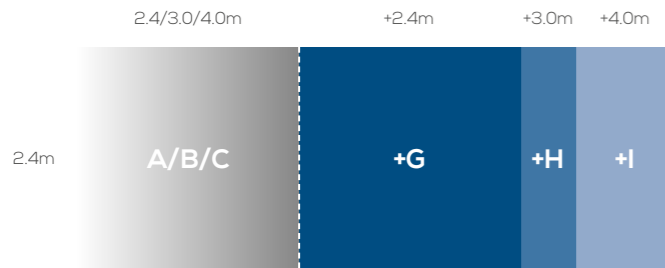

Adjoining Rooms	No Baffles			Acoustic Baffles*		
	£	€	\$	£	€	\$
G 2.4x2.4m	£4,700	€5,199	\$6,329	£6,573	€7,269	\$8,848
H 2.4x3.0m	£5,088	€5,628	\$6,850	£7,606	€8,412	\$10,240
I 2.4x4.0m	£5,401	€5,973	\$7,271	£9,006	€9,959	\$12,124

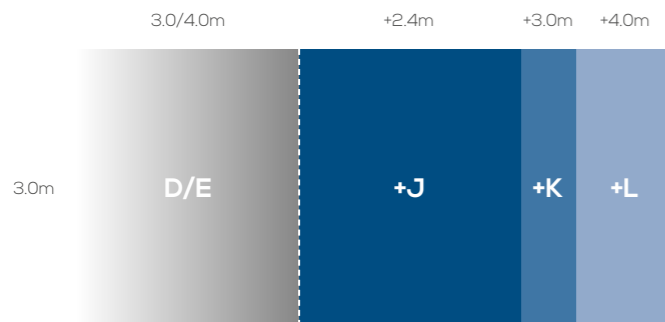

Adjoining Rooms	No Baffles			Acoustic Baffles*		
	£	€	\$	£	€	\$
J 3.0x2.4m	£5,009	€5,540	\$6,744	£7,527	€8,324	\$10,134
K 3.0x3.0m	£5,305	€5,868	\$7,143	£8,485	€9,383	\$11,423
L 3.0x4.0m	£5,621	€6,215	\$7,567	£9,822	€10,862	\$13,224

Wood Cladding

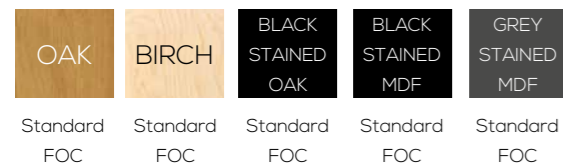

Standard FOC Standard FOC Standard FOC Standard FOC Standard FOC

Rooms Wall Options

The Rooms base structure has 4 open sides that can be filled by the following wall options

Acoustic Wall

Description: Fixed acoustic wall with Camira Sonus upholstered plywood frame & internal acoustic foam

Price	£	€	\$
2.4m	£3,604	€3,986	\$4,852
3.0m	£4,036	€4,464	\$5,435
4.0m	£5,260	€5,817	\$7,081

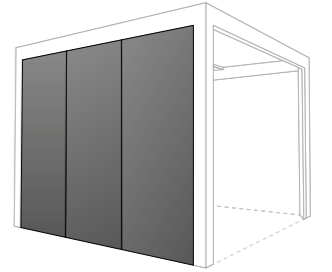

Curtain Wall

Description: Single Vescom Fogo sheer curtain & curtain rail

Price	£	€	\$
2.4m	£869	€962	\$1,171
3.0m	£1,085	€1,201	\$1,462
4.0m	£1,346	€1,490	\$1,813

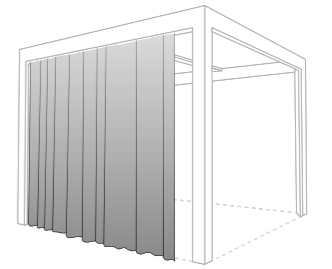

Glass Wall

Description: Fixed glass wall with optional glass door

Please note that the installation of Rooms with any glass elements can only be carried out by Connection or an approved sub contractor. There is an additional charge for this service. Please call customer services or ask your account manager for a quotation

Price - Without Door	£	€	\$	Price - With Door	£	€	\$
2.4m	£3,204	€3,558	\$4,327	2.4m	£4,902	€5,443	\$6,619
3.0m	£3,547	€3,938	\$4,790	3.0m	£5,224	€5,800	\$7,054
4.0m	£4,318	€4,794	\$5,830	4.0m	£5,911	€6,563	\$7,981

Please note that glass walls are held in place by an aluminium channel which is secured to the floor using a small number of 25mm screws.



Venetian Trellis Wall - Complete Wall

Description: Venetian trellis style wall with angled fixed birch or oak plywood slats & frame

Price - Birch Plywood	£	€	\$	Price - Oak Plywood	£	€	\$
2.4m - Complete Wall	£2,412	€2,669	\$3,249	2.4m - Complete Wall	£2,826	€3,126	\$3,804
3.0m - Complete Wall	£2,753	€3,045	\$3,707	3.0m - Complete Wall	£3,173	€3,509	\$4,273
4.0m - Complete Wall	£3,604	€3,986	\$4,852	4.0m - Complete Wall	£4,164	€4,605	\$5,606

Venetian Trellis Wall - With Openings

Price - Birch Plywood	£	€	\$	Price - Oak Plywood	£	€	\$
2.4m - 1 Panel Only	£1,362	€1,566	\$1,907	2.4m - 1 Panel Only	£1,635	€1,880	\$2,289
3.0m - 1 Panel Only	£1,157	€1,331	\$1,620	3.0m - 1 Panel Only	£1,377	€1,584	\$1,928
3.0m - 2 Panel Only	£1,955	€2,248	\$2,737	3.0m - 2 Panel Only	£2,275	€2,616	\$3,185
4.0m - 1 Panel Only	£1,210	€1,392	\$1,694	4.0m - 1 Panel Only	£1,470	€1,691	\$2,058
4.0m - 2 Panel Only	£2,008	€2,309	\$2,811	4.0m - 2 Panel Only	£2,368	€2,723	\$3,315
4.0m - 3 Panel Only	£2,806	€3,227	\$3,928	4.0m - 3 Panel Only	£3,266	€3,756	\$4,572

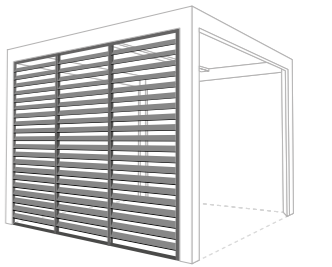

Trellis Finishes

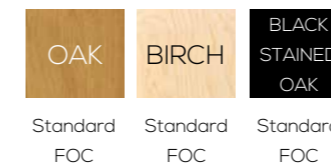

Standard FOC Standard FOC Standard FOC

Rooms Wall Options

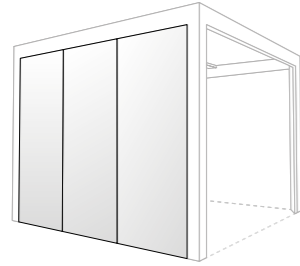

Whiteboard Wall

Description: Fixed dry wipe whiteboard wall comprising 3/4 whiteboard panels

Price	£	€	\$
2.4m	£1,930	€2,136	\$2,600
3.0m	£2,034	€2,250	\$2,740
4.0m	£2,656	€2,938	\$3,576

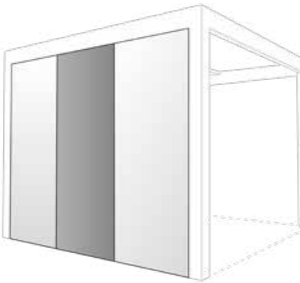

Whiteboard Media Wall

Description: Fixed dry wipe whiteboard wall with central media panel

Price	£	€	\$
2.4m	£2,921	€3,360	\$4,090
3.0m	£2,987	€3,436	\$4,182
4.0m	£3,823	€4,398	\$5,353

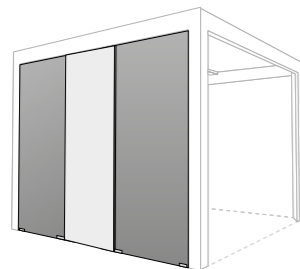

Upholstered Media Wall

Description: Fixed upholstered wall comprising 2 upholstered panels & oak veneer plywood centre panel. Fabric limited to Camira Sonus

Price	£	€	\$
2.4m	£2,738	€3,150	\$3,834
3.0m	£2,812	€3,235	\$3,938
4.0m	£3,536	€4,068	\$4,951

Rooms Wall Options & Power

Sunbeam Wall

Description: Fixed Sunbeam trellis wall with beech or oak veneer panel & frame

Price - Beech Plywood	£	€	\$	Price - Oak Veneer	£	€	\$
2.4m	£2,460	€2,829	\$3,444	2.4m	£2,560	€2,944	\$3,584
3.0m	£2,780	€3,197	\$3,892	3.0m	£2,880	€3,312	\$4,032
4.0m	£3,620	€4,163	\$5,068	4.0m	£3,720	€4,278	\$5,208

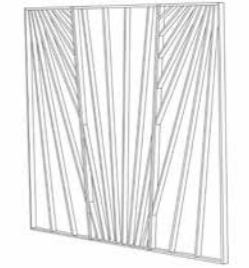

Woodland Wall

Description: Fixed Woodland trellis wall with beech or oak veneer panel & frame

Price - Beech Plywood	£	€	\$	Price - Oak Veneer	£	€	\$
2.4m	£1,910	€2,197	\$2,674	2.4m	£2,140	€2,461	\$2,996
3.0m	£2,100	€2,415	\$2,940	3.0m	£2,350	€2,703	\$3,290
4.0m	£2,820	€3,243	\$3,948	4.0m	£2,980	€3,427	\$4,172



Power Modules

Description: Power modules including extra cladding to facilitate cable management



Platforms
U-Shape configuration



Design by Roger Webb Associates



Underseat Storage



Gas Struts



Seat Cushions



Floor Covering



Integrated Power

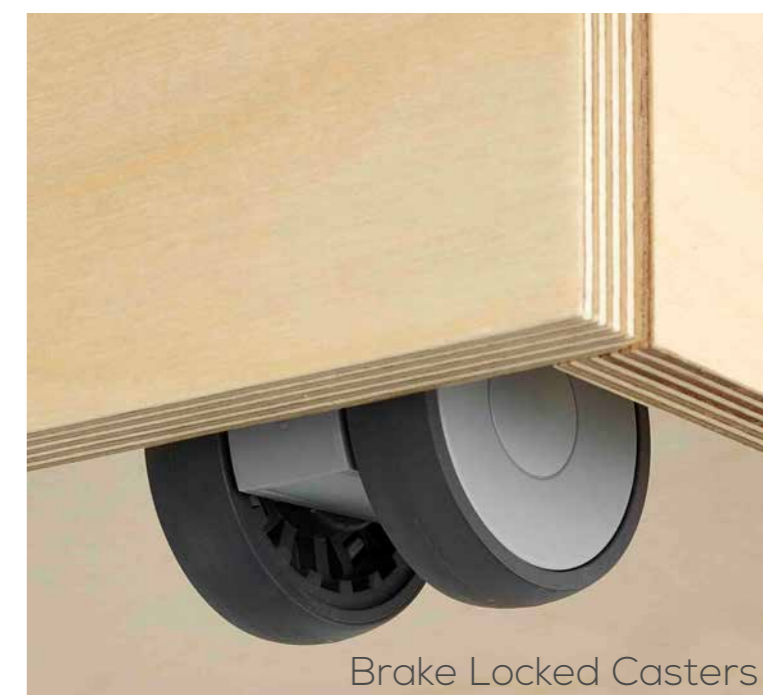

Brake Locked Casters

Platforms Modules

Platforms Example Configurations



Product Code: SPL1
Description: 1,350mm module with seat cushions & under-seat storage

Price	£	€	\$	Price	£	€	\$	Dimensions	
Group 0	£3,183	€3,520	\$4,285	Group 4	£3,269	€3,614	\$4,401	Height	834mm
Group 1	£3,200	€3,539	\$4,308	Group 5	£3,303	€3,653	\$4,447	Width	1,350mm
Group 2	£3,222	€3,563	\$4,337	Group 6	£3,450	€3,815	\$4,645	Depth	1,155mm
Group 3	£3,251	€3,595	\$4,377	Group 7	£3,510	€3,881	\$4,725	Seat Height	434/834mm
				Black Stained Birch	+£160	+€184	+\$224	Seat Depth	368mm
								Weight	74kg



Product Code: SPL2
Description: 1,540mm module with seat cushions & under-seat storage

Price	£	€	\$	Price	£	€	\$	Dimensions	
Group 0	£3,213	€3,553	\$4,325	Group 4	£3,310	€3,661	\$4,457	Height	834mm
Group 1	£3,231	€3,573	\$4,350	Group 5	£3,349	€3,703	\$4,508	Width	1,540mm
Group 2	£3,257	€3,603	\$4,385	Group 6	£3,516	€3,888	\$4,733	Depth	1,155mm
Group 3	£3,291	€3,639	\$4,430	Group 7	£3,583	€3,963	\$4,824	Seat Height	434/834mm
				Black Stained Birch	+£161	+€186	+\$226	Seat Depth	368mm
								Weight	82kg



Product Code: SPL3
Description: Corner module with seat cushions

Price	£	€	\$	Price	£	€	\$	Dimensions	
Group 0	£3,752	€4,150	\$5,052	Group 4	£3,821	€4,225	\$5,144	Height	834mm
Group 1	£3,767	€4,166	\$5,071	Group 5	£3,849	€4,256	\$5,182	Width	1,155mm
Group 2	£3,784	€4,184	\$5,094	Group 6	£3,965	€4,385	\$5,338	Depth	1,155mm
Group 3	£3,807	€4,210	\$5,126	Group 7	£4,014	€4,439	\$5,403	Seat Height	434/834mm
				Black Stained Birch	+£188	+€217	+\$264	Seat Depth	368mm
								Weight	85kg

Additional Standard Options

Bolon, Flow, Shell	£	€	\$	Interface, Cloud, 7335006	£	€	\$
SPL1	+£209	€231	\$281	SPL1	+£153	€169	\$206
SPL2	+£280	€309	\$376	SPL2	+£203	€224	\$272
SPL3	+£209	€231	\$281	SPL3	+£153	€169	\$206

Brake Locked Casters	£	€	\$
SPL1	+£171	€189	\$229
SPL2	+£171	€189	\$229
SPL3	+£198	€218	\$265

Wood



Standard FOC

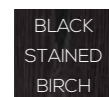

Special

Power

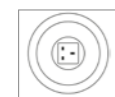

See pg 235

Flooring



Interface Cloud

Bolon Shell

Please note: The platforms product is constructed of birch ply and due to the nature of a natural material we are unable to offer warranties on the colour and uniformity of the wood grain. We make every effort to make sure that we minimise any variation within commercial tolerances from the batch the product is manufactured.

Configuration: L-shape

Modules
2 x SPL1, 1 x SPL3

Price	£	€	\$
Group 3	£10,309	€11,400	\$13,880
Black Stained Birch	+£508	+€564	+\$686

Dimensions

Height	834mm
Width	2,505mm
Depth	2,505mm
Seat Height	434/834mm
Seat Depth	368mm
Weight	381kg



Configuration: Straight

Modules
2 x SPL1

Price	£	€	\$
Group 3	£6,502	€7,190	\$8,753
Black Stained Birch	+£320	+€356	+\$432

Dimensions

Height	834mm
Width	2,700mm
Depth	1,155mm
Seat Height	434/834mm
Seat Depth	368mm
Weight	148kg



Configuration: Asymmetric L-shape

Modules
1 x SPL1, 2 x SPL2, 1 x SPL3

Price	£	€	\$
Group 3	£13,640	€15,083	\$18,363
Black Stained Birch	+£670	+€744	+\$905

Dimensions

Height	834mm
Width	4,235mm
Depth	2,505mm
Seat Height	434/834mm
Seat Depth	368mm
Weight	323kg



Configuration: U-shape

Modules
2 x SPL1, 1 x SPL2, 2 x SPL3

Price	£	€	\$
Group 3	£17,407	€19,249	\$23,433
Black Stained Birch	+£857	+€952	+\$1,157

Dimensions

Height	834mm
Width	3,850mm
Depth	2,505mm
Seat Height	434/834mm
Seat Depth	368mm
Weight	400kg



Wood



Standard FOC

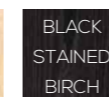

Special

Power



See pg 235

Please note: The platforms product is constructed of birch ply and due to the nature of a natural material we are unable to offer warranties on the colour and uniformity of the wood grain. We make every effort to make sure that we minimise any variation within commercial tolerances from the batch the product is manufactured.

Platforms
Additions



Design by Roger Webb Associates

Underseat
Storage



Birch Plywood Modular
Blocks



Seat Cushions



Platforms Additions Modular Building Blocks



Module Number	Product Code	Height (mm)	Width (mm)	Depth (mm)	Weight (kg)
1	SPB07/ST/UPH	1068	770	385	32
2	SPB07/HI/UPH	845	770	385	26
3	SPB07/MI/UPH	675	770	385	22
4	SPBSQ/MI/UPH	675	770	770	37
5	SPB07/LO/UPH	455	770	385	18
6	SPBSQ/LO/UPH	455	770	770	28
7	SPB11/LO/UPH	455	1155	385	23
8	SPB11/MI/UPH	675	1155	385	31
9	SPB11/HI/UPH	845	1155	385	36
10	SPB11/ST/UPH	1068	1155	385	45

Platforms Additions Example Configurations

Configuration: Lounge
Description: Communal and collaborative spaces

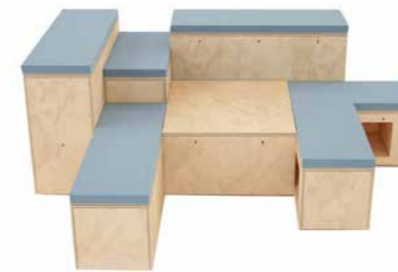

Modules:
 Module no.3 x 1 unit
 Module no.5 x 2 units
 Module no.6 x 1 unit
 Module no.7 x 1 unit
 Module no.9 x 2 units

Price	£	€	\$
Group 3	£9,709	€11,169	\$13,595
No upholstery	£7,256	€8,348	\$10,159
Black Stained Birch	+£455	+€524	+\$637

Dimensions

Height	845mm
Width	2,310mm
Depth	1,925mm
Weight	181kg

Configuration: Present
Description: Collaborative work and presentation spaces



Modules:
 Module no.3 x 2 units
 Module no.4 x 2 units
 Module no.6 x 2 units
 Module no.7 x 1 unit
 Module no.10 x 3 units

Price	£	€	\$
Group 3	£14,922	€17,169	\$20,893
No upholstery	£11,281	€12,979	\$15,797
Black Stained Birch	+£701	+€807	+\$982

Dimensions

Height	1,068mm
Width	3,465mm
Depth	1,540mm
Weight	420kg

Configuration: Socialise
Description: Informal meeting and socialising spaces



Modules:
 Module no.1 x 2 units
 Module no.2 x 1 unit
 Module no.3 x 1 unit
 Module no.4 x 1 unit
 Module no.5 x 2 units
 Module no.6 x 1 unit
 Module no.7 x 2 units
 Module no.8 x 1 unit
 Module no.9 x 1 unit
 Module no.10 x 1 unit

Price	£	€	\$
Group 3	£18,376	€21,141	\$25,731
No upholstery	£13,827	€15,909	\$19,361
Black Stained Birch	+£870	+€1,001	+\$1,218

Dimensions

Height	1,068mm
Width	3,850mm
Depth	2,310mm
Weight	371kg

Configuration: CoWork
Description: Multiple work styles and CoWorking spaces



Modules:
 Module no.1 x 3 units
 Module no.5 x 2 units
 Module no.6 x 1 unit
 Module no.7 x 1 unit
 Module no.10 x 3 units

Price	£	€	\$
Group 3	£14,738	€16,958	\$20,637
No upholstery	£11,262	€12,958	\$15,770
Black Stained Birch	+£693	+€797	+\$971

Dimensions

Height	1,068mm
Width	3,465mm
Depth	2,310mm
Weight	318kg

Please note: mixed upholstered configurations shown.

Platforms Additions Modules

Platforms Additions Modules



Module number 1

Product Code: SPB07/ST/UPH
Description: Standard width high module

Un-Upholstered Module Price			Black Stained Birch			+£69/+€80/+\$97			
£	€	\$	£	€	\$	Dimensions			
Group 0	£1,370	€1,576	\$1,918	Group 4	£1,502	€1,728	\$2,103	Height	1,068mm
Group 1	£1,398	€1,608	\$1,958	Group 5	£1,549	€1,782	\$2,169	Width	770mm
Group 2	£1,436	€1,652	\$2,011	Group 6	£1,691	€1,945	\$2,367	Depth	385mm
Group 3	£1,464	€1,685	\$2,050	Group 7	£1,785	€2,053	\$2,499	Weight	32kg



Module number 2

Product Code: SPB07/HI/UPH
Description: Standard width tall module

Un-Upholstered Module Price			Black Stained Birch			+£60/+€69/+\$84			
£	€	\$	£	€	\$	Dimensions			
Group 0	£1,193	€1,373	\$1,671	Group 4	£1,326	€1,526	\$1,857	Height	845mm
Group 1	£1,222	€1,406	\$1,712	Group 5	£1,373	€1,580	\$1,922	Width	770mm
Group 2	£1,259	€1,448	\$1,763	Group 6	£1,515	€1,743	\$2,121	Depth	385mm
Group 3	£1,288	€1,481	\$1,804	Group 7	£1,609	€1,851	\$2,253	Weight	26kg



Module number 3

Product Code: SPB07/MI/UPH
Description: Standard width mid module

Un-Upholstered Module Price			Black Stained Birch			+£56/+€65/+\$79			
£	€	\$	£	€	\$	Dimensions			
Group 0	£1,119	€1,287	\$1,567	Group 4	£1,251	€1,439	\$1,752	Height	675mm
Group 1	£1,147	€1,319	\$1,606	Group 5	£1,298	€1,493	\$1,818	Width	770mm
Group 2	£1,185	€1,364	\$1,660	Group 6	£1,440	€1,656	\$2,017	Depth	385mm
Group 3	£1,213	€1,396	\$1,698	Group 7	£1,535	€1,766	\$2,150	Weight	22kg



Module number 4

Product Code: SPBSQ/MI/UPH
Description: Square mid module

Un-Upholstered Module Price			Black Stained Birch			+£77/+€89/+\$108			
£	€	\$	£	€	\$	Dimensions			
Group 0	£1,527	€1,757	\$2,138	Group 4	£1,659	€1,908	\$2,323	Height	675mm
Group 1	£1,556	€1,790	\$2,179	Group 5	£1,707	€1,963	\$2,390	Width	770mm
Group 2	£1,593	€1,832	\$2,230	Group 6	£1,848	€2,125	\$2,587	Depth	770mm
Group 3	£1,622	€1,866	\$2,271	Group 7	£1,943	€2,235	\$2,720	Weight	37kg



Module number 5

Product Code: SPB07/LO/UPH
Description: Standard width low module (inc casters and storage)

Un-Upholstered Module Price			Black Stained Birch			+£60/+€69/+\$84			
£	€	\$	£	€	\$	Dimensions			
Group 0	£1,189	€1,368	\$1,665	Group 4	£1,321	€1,519	\$1,850	Height	455mm
Group 1	£1,217	€1,400	\$1,704	Group 5	£1,369	€1,575	\$1,917	Width	770mm
Group 2	£1,255	€1,444	\$1,757	Group 6	£1,510	€1,737	\$2,115	Depth	385mm
Group 3	£1,284	€1,477	\$1,798	Group 7	£1,605	€1,847	\$2,248	Weight	18kg

Module number 6

Product Code: SPBSQ/LO/UPH
Description: Square low module

Un-Upholstered Module Price			Black Stained Birch			+£69/+€80/+\$97			
£	€	\$	£	€	\$	Dimensions			
Group 0	£1,379	€1,586	\$1,931	Group 4	£1,511	€1,738	\$2,116	Height	455mm
Group 1	£1,407	€1,618	\$1,970	Group 5	£1,559	€1,793	\$2,183	Width	770mm
Group 2	£1,445	€1,662	\$2,024	Group 6	£1,700	€1,955	\$2,380	Depth	770mm
Group 3	£1,474	€1,696	\$2,064	Group 7	£1,795	€2,065	\$2,513	Weight	28kg



Module number 7

Product Code: SPB11/LO/UPH
Description: Wide width low module (inc casters and storage)

Un-Upholstered Module Price			Black Stained Birch			+£66/+€76/+\$93			
£	€	\$	£	€	\$	Dimensions			
Group 0	£1,308	€1,504	\$1,831	Group 4	£1,440	€1,656	\$2,017	Height	455mm
Group 1	£1,336	€1,537	\$1,871	Group 5	£1,487	€1,711	\$2,082	Width	1,155mm
Group 2	£1,374	€1,581	\$1,924	Group 6	£1,629	€1,874	\$2,281	Depth	385mm
Group 3	£1,402	€1,613	\$1,963	Group 7	£1,724	€1,983	\$2,414	Weight	23kg



Module number 8

Product Code: SPB11/MI/UPH
Description: Wide width mid module

Un-Upholstered Module Price			Black Stained Birch			+£62/+€72/+\$87			
£	€	\$	£	€	\$	Dimensions			
Group 0	£1,225	€1,409	\$1,716	Group 4	£1,357	€1,561	\$1,900	Height	675mm
Group 1	£1,253	€1,441	\$1,755	Group 5	£1,404	€1,615	\$1,966	Width	1,155mm
Group 2	£1,291	€1,485	\$1,808	Group 6	£1,546	€1,778	\$2,165	Depth	385mm
Group 3	£1,319	€1,517	\$1,847	Group 7	£1,641	€1,888	\$2,298	Weight	31kg



Module number 9

Product Code: SPB11/HI/UPH
Description: Wide width tall module

Un-Upholstered Module Price			Black Stained Birch			+£72/+€83/+\$101			
£	€	\$	£	€	\$	Dimensions			
Group 0	£1,432	€1,647	\$2,006	Group 4	£1,564	€1,799	\$2,190	Height	845mm
Group 1	£1,460	€1,680	\$2,044	Group 5	£1,611	€1,854	\$2,256	Width	1,155mm
Group 2	£1,498	€1,723	\$2,098	Group 6	£1,753	€2,017	\$2,455	Depth	385mm
Group 3	£1,526	€1,755	\$2,137	Group 7	£1,847	€2,124	\$2,586	Weight	36kg



Module number 10

Product Code: SPB11/ST/UPH
Description: Wide width high module

Un-Upholstered Module Price			Black Stained Birch			+£77/+€89/+\$108			
£	€	\$	£	€	\$	Dimensions			
Group 0	£1,540	€1,771	\$2,157	Group 4	£1,672	€1,923	\$2,341	Height	1,068mm
Group 1	£1,568	€1,803	\$2,196	Group 5	£1,719	€1,977	\$2,407	Width	1,155mm
Group 2	£1,606	€1,848	\$2,249	Group 6	£1,861	€2,140	\$2,606	Depth	385mm
Group 3	£1,634	€1,880	\$2,288	Group 7	£1,956	€2,250	\$2,739	Weight	45kg



Wood



Standard FOC Special

Please note: The platforms product is constructed of birch ply and due to the nature of a natural material we are unable to offer warranties on the colour and uniformity of the wood grain. We make every effort to make sure that we minimise any variation within commercial tolerances from the batch the product is manufactured.

Please remove an approx. weight of 2kg per module for un-upholstered modules.

Wood



Standard FOC Special

Please note: The platforms product is constructed of birch ply and due to the nature of a natural material we are unable to offer warranties on the colour and uniformity of the wood grain. We make every effort to make sure that we minimise any variation within commercial tolerances from the batch the product is manufactured.

Please remove an approx. weight of 2kg per module for un-upholstered modules.

Platforms
Accessories



Design by Roger Webb Associates

Planters (Black Stain)



Shelving Units



Planters



Platforms Accessories Backboards



Product Code: SPL1/BBRD/D0375 (wood effect laminate), SPL1/BBRD/U763 (grey laminate)
Description: 1,350mm wide upholstered backboard, to attach to Platforms module SPL1. Available in wood effect or grey laminate. Please note backboards are only available on Platforms modules, not Platforms Additions

	£	€	\$		£	€	\$	Dimensions
Group 0	£1,033	€1,188	\$1,447	Group 4	£1,138	€1,309	\$1,594	Height 1,195mm
Group 1	£1,055	€1,214	\$1,477	Group 5	£1,175	€1,352	\$1,645	Width 1,350mm
Group 2	£1,085	€1,248	\$1,519	Group 6	£1,288	€1,482	\$1,804	Depth 50mm
Group 3	£1,108	€1,275	\$1,552	Group 7	£1,363	€1,568	\$1,909	Weight 22kg



Product Code: SPL2/BBRD/D0375 (wood effect laminate), SPL2/BBRD/U763 (grey laminate)
Description: 1,540mm wide upholstered backboard, to attach to Platforms module SPL2. Available in wood effect or grey laminate. Please note backboards are only available on Platforms modules, not Platforms Additions

	£	€	\$		£	€	\$	Dimensions
Group 0	£1,254	€1,443	\$1,756	Group 4	£1,373	€1,579	\$1,923	Height 1,195mm
Group 1	£1,280	€1,472	\$1,792	Group 5	£1,416	€1,629	\$1,983	Width 1,540mm
Group 2	£1,314	€1,512	\$1,840	Group 6	£1,543	€1,775	\$2,161	Depth 50mm
Group 3	£1,339	€1,540	\$1,875	Group 7	£1,628	€1,873	\$2,280	Weight 27kg



Product Code: SPL3/BBRD/D0375 (wood effect laminate), SPL3/BBRD/U763 (grey laminate)
Description: Corner unit upholstered backboard, to attach to Platforms module SPL3. Available in wood effect or grey laminate. Please note backboards are only available on Platforms modules, not Platforms Additions

	£	€	\$		£	€	\$	Dimensions
Group 0	£1,752	€2,015	\$2,453	Group 4	£1,843	€2,120	\$2,581	Height 1,195mm
Group 1	£1,771	€2,037	\$2,480	Group 5	£1,875	€2,157	\$2,625	Width 1,155mm
Group 2	£1,797	€2,067	\$2,516	Group 6	£1,973	€2,269	\$2,763	Depth 1,155mm
Group 3	£1,817	€2,090	\$2,544	Group 7	£2,038	€2,344	\$2,854	Weight 18kg

Laminates



Standard FOC Standard FOC

Platforms Accessories

Product Code: SPB07/ST/SHV
Description: 770mm wide shelving unit

	£	€	\$	Dimensions
	£1,686	€1,939	\$2,361	Height 1,018mm
				Width 770mm
				Depth 385mm
				Weight 31kg



Product Code: SPB11/ST/SHV
Description: 1,155mm wide shelving unit

	£	€	\$	Dimensions
	£1,741	€2,003	\$2,438	Height 1,018mm
				Width 1,155mm
				Depth 385mm
				Weight 40kg



Product Code: SPB07/ST/PLT
Description: 770mm wide planter unit

	£	€	\$	Dimensions
	£2,036	€2,342	\$2,851	Height 1,018mm
				Width 770mm
				Depth 385mm
				Weight 31kg



Product Code: SPB11/ST/PLT
Description: 1,155mm wide planter unit

	£	€	\$	Dimensions
	£2,316	€2,664	\$3,243	Height 1,018mm
				Width 1,155mm
				Depth 385mm
				Weight 44kg



Product Code: SPB07/WHITEBOARD
Description: 770mm wide double-sided whiteboard with dry-wipe surface (unit pictured not included)

	£	€	\$	Dimensions
	£931	€1,071	\$1,304	Height 1,750mm
				Width 770mm
				Depth 18mm
				Weight 15kg



Product Code: SPB11/WHITEBOARD
Description: 1,155mm wide double-sided whiteboard with dry-wipe surface (unit pictured not included)

	£	€	\$	Dimensions
	£945	€1,087	\$1,323	Height 1,750mm
				Width 1,155mm
				Depth 18mm
				Weight 26kg



Tier

18 seat configuration



Design by Workplace Projects

Seat Cushions & Floor Covering



Simple On Site Assembly

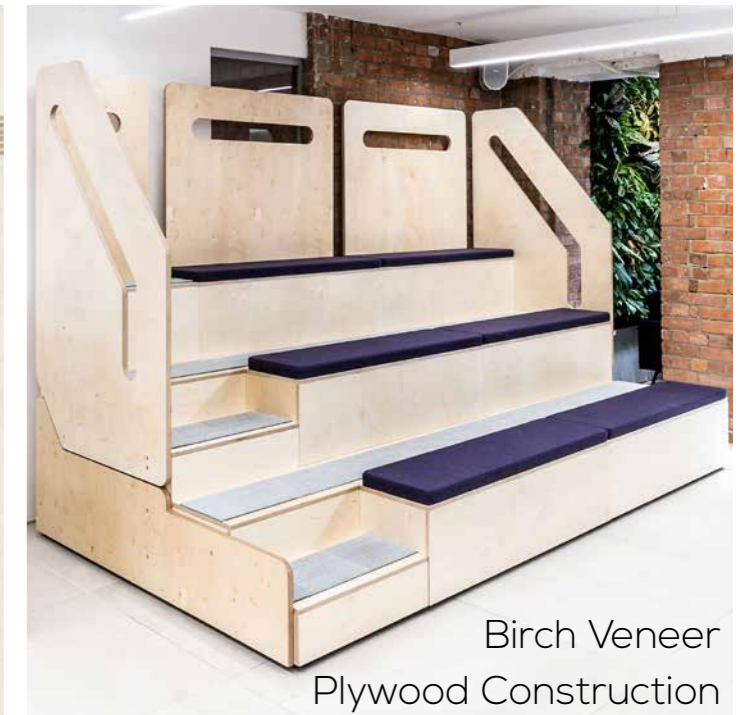

Birch Veneer
Plywood Construction

Back & Side Balustrades



Tier Modules

Tier Example Configurations



Product Code: STE1
Description: Straight 3-tier seating module with upholstery & floor covering, including back balustrade

Price	£	€	\$	Price	£	€	\$	Dimensions	
Group 0	£5,174	€5,722	\$6,965	Group 4	£5,392	€5,963	\$7,259	Height	2,034mm
Group 1	£5,221	€5,773	\$7,028	Group 5	£5,470	€6,049	\$7,364	Width	1,200mm
Group 2	£5,283	€5,842	\$7,112	Group 6	£5,704	€6,308	\$7,679	Depth	1,770mm
Group 3	£5,330	€5,894	\$7,175	Group 7	£5,860	€6,481	\$7,889	Seat Height	435/785/1,135mm



Product Code: STE2
Description: Angled 3-tier seating module with upholstery & floor covering, including back balustrade

Price	£	€	\$	Price	£	€	\$	Dimensions	
Group 0	£5,253	€5,809	\$7,072	Group 4	£5,471	€6,051	\$7,366	Height	2,034mm
Group 1	£5,300	€5,861	\$7,135	Group 5	£5,549	€6,137	\$7,471	Width	600-1,200mm
Group 2	£5,362	€5,930	\$7,219	Group 6	£5,783	€6,396	\$7,786	Depth	1,770mm
Group 3	£5,409	€5,982	\$7,282	Group 7	£5,939	€6,568	\$7,996	Seat Height	435/785/1,135mm



Product Code: STE3
Description: Stepped access module with floor covering, including back balustrade

Price	£	€	\$	Dimensions	
	£3,285	€3,633	\$4,423	Height	2,034mm
				Width	600mm
				Depth	1,770mm



Product Code: STE4
Description: End of run balustrade

Price	£	€	\$	Dimensions	
	£1,668	€1,845	\$2,246	Height	2,034mm
				Depth	1,770mm

Additional Options: Tier modules minus back balustrade
Disclaimer: Tier units without balustrades must be positioned against a wall in order to meet health and safety requirements. Connection will not be held accountable for any issues resulting from balustrades being omitted

Price	£	€	\$
STE1	-£546	-€603	-\$735
STE2	-£546	-€603	-\$735
STE3	-£359	-€396	-\$483

Wood



Standard
FOC

Flooring



Interface
Cloud

Configuration: 12 seat

Modules: 2 x STE1, 1 x STE3, 2 x STE4

Price	£	€	\$	Dimensions	
Group 3	£17,281	€19,111	\$23,265	Height	2,034mm
				Width	3,020mm
				Depth	1,770mm
				Seat Height	435/785/1,135mm



Configuration: 16 seat

Modules: 2 x STE1, 1 x STE2, 2 x STE3, 2 x STE4

Price	£	€	\$	Dimensions	
Group 3	£25,975	€28,726	\$34,970	Height	2,034mm
				Width	4,765mm
				Depth	2,060mm
				Seat Height	435/785/1,135mm



Configuration: 20 seat

Modules: 2 x STE1, 2 x STE2, 1 x STE3, 2 x STE4

Price	£	€	\$	Dimensions	
Group 3	£28,099	€31,075	\$37,829	Height	2,034mm
				Width	5,380mm
				Depth	1,875mm
				Seat Height	435/785/1,135mm



Configuration: 26 seat

Modules: 3 x STE1, 2 x STE2, 2 x STE3, 2 x STE4

Price	£	€	\$	Dimensions	
Group 3	£36,714	€40,602	\$49,427	Height	2,034mm
				Width	6,970mm
				Depth	2,485mm
				Seat Height	435/785/1,135mm



Wood



Standard
FOC

Flooring



Interface
Cloud

Tier

18 seat configuration



Tryst Booths

Design by Roger Webb Associates



Integrated Power Options

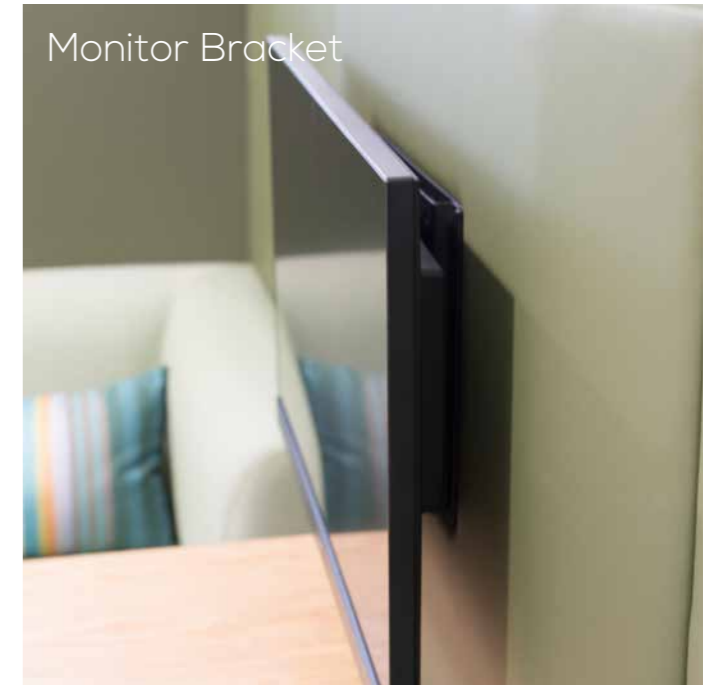

Monitor Bracket



Sprung Seats



Oak Legs (Special)



Black & Polished Aluminium Legs



Oak, Black & White Console Finishes

Integral lamp



Integrated Work Surfaces

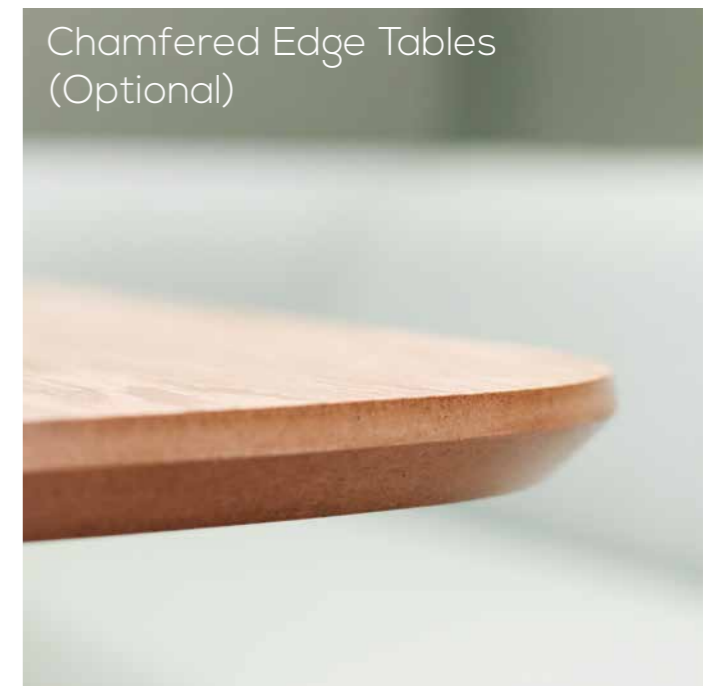

Chamfered Edge Tables (Optional)

Tryst High Back Media Booths



Product Code: STK7
Description: High back 2 seat booth with integrated work surface. Available with black metal or polished aluminium legs. Solid oak legs also available (upgrade cost applies)

Price	£	€	\$	Dimensions
Group 3	£7,238	€8,004	\$9,744	Height 1,335mm
Group 4	£7,548	€8,347	\$10,162	Width 2,430mm
Group 5	£7,792	€8,616	\$10,489	Depth 995mm
Group 6	£9,090	€10,051	\$12,236	Seat Height 480mm
				Weight 90kg



Product Code: STK8
Description: High back 4 seat booth with integrated work surface. Available with black metal or polished aluminium legs. Solid oak legs also available (upgrade cost applies)

Price	£	€	\$	Dimensions
Group 3	£8,776	€9,704	\$11,814	Height 1,335mm
Group 4	£9,292	€10,276	\$12,509	Width 2,430mm
Group 5	£9,747	€10,778	\$13,121	Depth 1,640mm
Group 6	£11,804	€13,053	\$15,890	Seat Height 480mm
				Weight 115kg



Product Code: STK9
Description: High back 6 seat booth with integrated work surface. Available with black metal or polished aluminium legs. Solid oak legs also available (upgrade cost applies)

Price	£	€	\$	Dimensions
Group 3	£10,102	€11,170	\$13,599	Height 1,335mm
Group 4	£10,600	€11,721	\$14,269	Width 2,430mm
Group 5	£11,239	€12,429	\$15,130	Depth 2,290mm
Group 6	£13,840	€15,305	\$18,632	Seat Height 480mm
				Weight 145kg

Product Options	£	€	\$
TV Mounting Bracket	£78	€87	\$105

Metal Leg

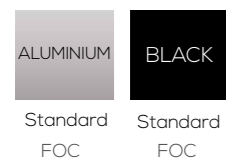

Wood Leg

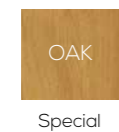

Work Surface

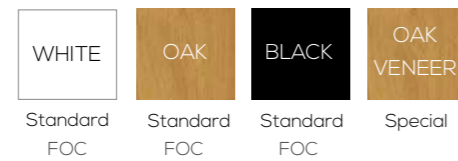

Power Fabrics

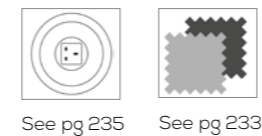

Metal Leg

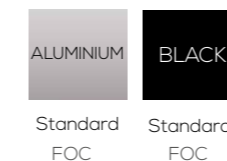

Wood Leg

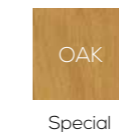

Work Surface

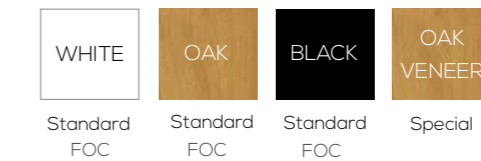

Power Fabrics



Tryst Low Back Booths

Product Code: STK20 (with integrated work surface), STK23 (without integrated work surface)
Description: Low back 2 seat booth with/without integrated work surface. Available with black metal or polished aluminium legs. Solid oak legs also available (upgrade cost applies)

Price - STK20	£	€	\$	Price - STK23	£	€	\$	Dimensions
Group 3	£4,341	€4,801	\$5,844	Group 3	£4,118	€4,554	\$5,544	Height 763mm
Group 4	£4,531	€5,011	\$6,100	Group 4	£4,276	€4,729	\$5,757	Width 2,430mm
Group 5	£4,710	€5,209	\$6,341	Group 5	£4,425	€4,894	\$5,957	Depth 995mm
Group 6	£5,492	€6,074	\$7,394	Group 6	£5,078	€5,616	\$6,837	Seat Height 480mm
								Weight 144kg (STK20) 138kg (STK23)



Product Code: STK21 (with integrated work surface), STK24 (without integrated work surface)
Description: Low back 4 seat booth with/without integrated work surface. Available with black metal or polished aluminium legs. Solid oak legs also available (upgrade cost applies)

Price - STK21	£	€	\$	Price - STK24	£	€	\$	Dimensions
Group 3	£5,921	€6,547	\$7,971	Group 3	£5,315	€5,878	\$7,156	Height 763mm
Group 4	£6,176	€6,829	\$8,314	Group 4	£5,571	€6,161	\$7,500	Width 2,430mm
Group 5	£6,792	€7,511	\$9,144	Group 5	£6,188	€6,843	\$8,330	Depth 1,640mm
Group 6	£7,525	€8,322	\$10,131	Group 6	£6,919	€7,651	\$9,315	Seat Height 480mm
								Weight 176kg (STK21) 167kg (STK24)



Product Code: STK22 (with integrated work surface), STK25 (without integrated work surface)
Description: Low back 6 seat booth with/without integrated work surface. Available with black metal or polished aluminium legs. Solid oak legs also available (upgrade cost applies)

Price - STK22	£	€	\$	Price - STK25	£	€	\$	Dimensions
Group 3	£6,715	€7,426	\$9,040	Group 3	£6,025	€6,662	\$8,111	Height 763mm
Group 4	£7,022	€7,765	\$9,453	Group 4	£6,332	€7,002	\$8,524	Width 2,430mm
Group 5	£7,305	€8,078	\$9,834	Group 5	£6,614	€7,314	\$8,904	Depth 2,290mm
Group 6	£8,717	€9,640	\$11,735	Group 6	£8,026	€8,875	\$10,804	Seat Height 480mm
								Weight 236kg (STK22) 225kg (STK25)



Special Options	£	€	\$
Oak legs	+£508	+€562	+\$684
Oak veneer chamfered edges (STK7)	+£171	+€190	+\$231
Oak veneer chamfered edges (STK8)	+£203	+€225	+\$273
Oak veneer chamfered edges (STK9)	+£230	+€255	+\$310

Tryst Consoles



Product Code: STK13

Description: Low back single seat console unit. Available with black metal or polished aluminium legs. Solid oak legs also available (upgrade cost applies). Console tops also available in alternative finishes (please see below).

Price	£	€	\$	Dimensions
Group 3	£3,613	€4,036	\$4,962	Height 763mm
Group 4	£3,948	€4,411	\$5,423	Width 1,250mm
Group 5	£4,126	€4,610	\$5,667	Depth 810mm
Group 6	£4,862	€5,432	\$6,678	Seat Height 480mm
				Weight 78kg



Product Code: STK12 (for Integral lamp, see page 39)

Description: High back single seat console unit. Available with black metal or polished aluminium legs. Solid oak legs also available (upgrade cost applies). Console tops also available in alternative finishes (please see below).

Price	£	€	\$	Dimensions
Group 3	£3,908	€4,367	\$5,369	Height 1,335mm
Group 4	£4,185	€4,676	\$5,748	Width 1,250mm
Group 5	£4,392	€4,906	\$6,032	Depth 810mm
Group 6	£5,338	€5,964	\$7,332	Seat Height 480mm
				Weight 85kg



Product Code: STK10

Description: Low back 2 seat console unit. Available with black metal or polished aluminium legs. Solid oak legs also available (upgrade cost applies). Console tops also available in alternative finishes (please see below).

Price	£	€	\$	Dimensions
Group 3	£4,353	€4,863	\$5,979	Height 763mm
Group 4	£4,529	€5,060	\$6,221	Width 2,286mm
Group 5	£4,676	€5,223	\$6,422	Depth 810mm
Group 6	£5,493	€6,137	\$7,545	Seat Height 480mm
				Weight 125kg



Product Code: STK11

Description: High back 2 seat console unit. Available with black metal or polished aluminium legs. Solid oak legs also available (upgrade cost applies). Console tops also available in alternative finishes (please see below).

Price	£	€	\$	Dimensions
Group 3	£4,873	€5,444	\$6,693	Height 1,335mm
Group 4	£5,100	€5,698	\$7,005	Width 2,286mm
Group 5	£5,326	€5,950	\$7,316	Depth 810mm
Group 6	£6,459	€7,217	\$8,873	Seat Height 480mm
				Weight 134kg

Metal Leg

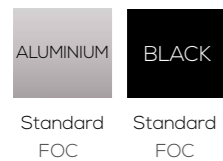

Wood Leg

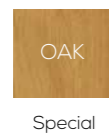

Work Surface

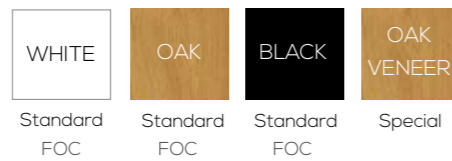

Power



See pg 235

Fabrics



See pg 233

Tryst Canopy Booths

Product Code: STK14

Description: Armchair with canopy and 1 LED light. Available with black metal or polished aluminium legs. Solid oak legs also available (upgrade cost applies).

Price	£	€	\$	Dimensions
Group 3	£3,945	€4,407	\$5,418	Height 1,720mm
Group 4	£4,051	€4,525	\$5,564	Width 980mm
Group 5	£4,166	€4,655	\$5,723	Depth 810mm
Group 6	£4,269	€4,769	\$5,864	Seat Height 480mm
				Weight 90kg



Product Code: STK15

Description: 2 seat sofa with canopy and 2 LED lights. Available with black metal or polished aluminium legs. Solid oak legs also available (upgrade cost applies).

Price	£	€	\$	Dimensions
Group 3	£6,202	€6,929	\$8,519	Height 1,720mm
Group 4	£6,371	€7,118	\$8,751	Width 1,620mm
Group 5	£6,542	€7,308	\$8,985	Depth 810mm
Group 6	£6,714	€7,501	\$9,222	Seat Height 480mm
				Weight 105kg



Product Code: STK16

Description: Single seat console unit with canopy and 1 LED light. Available with black metal or polished aluminium legs. Solid oak legs also available (upgrade cost applies). Console tops also available in black laminate at no extra charge.

Price	£	€	\$	Dimensions
Group 3	£5,055	€5,648	\$6,944	Height 1,720mm
Group 4	£5,388	€6,020	\$7,401	Width 1,250mm
Group 5	£5,652	€6,315	\$7,764	Depth 810mm
Group 6	£6,657	€7,437	\$9,144	Seat Height 480mm
				Weight 105kg



Special Options	£	€	\$
Oak legs	+£254	+€281	+\$342

Metal Leg

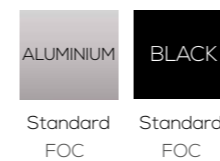

Wood Leg

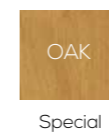

Work Surface

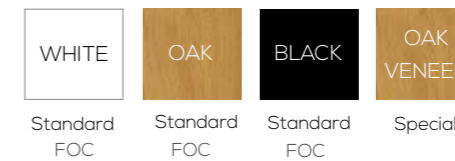

Power

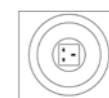

See pg 235

Fabrics



See pg 233

Tryst Canopy Booths & Accessories

Tryst

High back 4 seat abooth with canopy



Product Code: STK52

Description: High back 2 seat booth with canopy and integrated work surface. Available with black metal or polished aluminium legs. Solid oak legs also available (upgrade cost applies)

Price	£	€	\$	Dimensions
Group 3	£9,707	€10,735	\$13,068	Height 1,720mm
Group 4	£9,969	€11,024	\$13,421	Width 2,430mm
Group 5	£10,236	€11,319	\$13,779	Depth 995mm
Group 6	£10,643	€11,770	\$14,328	Seat Height 480mm



Product Code: STK51

Description: High back 4 seat booth with canopy and integrated work surface. Available with black metal or polished aluminium legs. Solid oak legs also available (upgrade cost applies)

Price	£	€	\$	Dimensions
Group 3	£14,221	€15,726	\$19,144	Height 1,720mm
Group 4	£14,610	€16,156	\$19,668	Width 2,430mm
Group 5	£14,993	€16,579	\$20,183	Depth 1,640mm
Group 6	£15,533	€17,177	\$20,911	Seat Height 480mm



Description: Tryst console lamp with off-white lampshade & white, black or silver lamp stem. Light bulbs are not supplied

Product Code	£	€	\$
LAMPTRYSTA Lamp stem complete with square lampshade	£195	€225	\$275
LAMPTRYSTB Lamp stem complete with large rectangular lampshade	£208	€240	\$292
STEM ONLY Lamp stem only (no lampshade)	£133	€153	\$187

Special Options	£	€	\$
Oak legs	+£508	+€562	+\$684
Reverse chamfered edges (STK52)	+£165	+€182	+\$222
Reverse chamfered edges (STK51)	+£203	+€225	+\$273
Monitor Bracket up to 40" & 80kg	+£78	+€87	+\$105

Metal Leg



Standard FOC

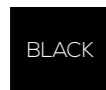

Standard FOC

Wood Leg



Special

Work Surface



Standard FOC



Standard FOC

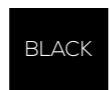

Standard FOC

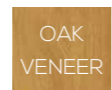

Special

Power Fabrics



See pg 235



See pg 233





Product Code: SCX/2BTH
Description: High back 2 seat booth with integrated work surface. Available with smooth black metal legs and free-standing power options.

Price	£	€	\$	Dimensions	
Group 3	£5,433	€6,249	\$7,607	Height	1295mm
Group 4	£5,711	€6,568	\$7,996	Width	2415mm
Group 5	£6,058	€6,967	\$8,482	Depth	980mm
Group 6	£7,099	€8,165	\$9,940	Seat Height	425mm
Group 7	£7,794	€8,963	\$10,911	Weight	142kg



Product Code: SCX/4BTH
Description: High back 4 seat booth with integrated work surface. Available with smooth black metal legs and free-standing power options.

Price	£	€	\$	Dimensions	
Group 3	£6,067	€6,978	\$8,495	Height	1295mm
Group 4	£6,413	€7,375	\$8,978	Width	2415mm
Group 5	£6,844	€7,872	\$9,583	Depth	1625mm
Group 6	£8,139	€9,361	\$11,396	Seat Height	425mm
Group 7	£9,003	€10,354	\$12,604	Weight	160kg



Product Code: SCX/LLOW
Description: Low back armchair with smooth black metal legs.

Price	£	€	\$	Dimensions	
Group 3	£1,505	€1,731	\$2,107	Height	760mm
Group 4	£1,575	€1,812	\$2,205	Width	885mm
Group 5	£1,662	€1,911	\$2,327	Depth	740mm
Group 6	£1,922	€2,211	\$2,691	Seat Height	425mm
Group 7	£2,096	€2,410	\$2,934	Weight	33kg



Product Code: SCX/HGH
Description: High back armchair with smooth black metal legs.

Price	£	€	\$	Dimensions	
Group 3	£2,195	€2,525	\$3,074	Height	1295mm
Group 4	£2,316	€2,664	\$3,243	Width	980mm
Group 5	£2,467	€2,838	\$3,455	Depth	770mm
Group 6	£2,921	€3,360	\$4,090	Seat Height	425mm
Group 7	£3,224	€3,708	\$4,514	Weight	61kg

Metal Leg



Standard FOC

Work Surface



Standard FOC



Standard FOC



Standard FOC



Standard FOC



See pg 233

Fabrics

Product Code: SCX/2LOW
Description: Low back 2 seat sofa with smooth black metal legs.

Price	£	€	\$	Dimensions	
Group 3	£1,898	€2,183	\$2,658	Height	760mm
Group 4	£1,982	€2,279	\$2,775	Width	1530mm
Group 5	£2,086	€2,400	\$2,921	Depth	740mm
Group 6	£2,400	€2,760	\$3,360	Seat Height	425mm
Group 7	£2,609	€3,001	\$3,653	Weight	38kg



Product Code: SCX/2HGH
Description: High back 2 seat armchair with smooth black metal legs.

Price	£	€	\$	Dimensions	
Group 3	£2,571	€2,958	\$3,601	Height	1295mm
Group 4	£2,726	€3,136	\$3,817	Width	1625mm
Group 5	£2,920	€3,358	\$4,088	Depth	770mm
Group 6	£3,501	€4,026	\$4,901	Seat Height	425mm
Group 7	£3,888	€4,471	\$5,443	Weight	70kg



Power Options	£	€	\$
Crux Power Type D	+£218	+€251	+\$305
Monitor Bracket up to 40" & 80kg	+£122	+€140	+\$171



Metal Leg

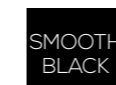

Standard FOC

Work Surface



Standard FOC



Standard FOC

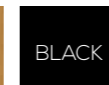

Standard FOC



Standard FOC



See pg 233

Fabrics

Nomad

Two seater sofa, two seater table & low media unit

Booths



Product Description: 1, 2 or 3 seater unit with a high lacquered birch ply surround, sprung seat and fully mobile on break loaded casters.

Product Code: SND/1STR
Description: Single seater

Price	£	€	\$
Group 3	£2,304	€2,650	\$3,226
Group 4	£2,417	€2,780	\$3,384
Group 5	£2,503	€2,879	\$3,505
Group 6	£2,969	€3,415	\$4,157

Product Code: SND/2STR
Description: Two seater

Price	£	€	\$
Group 3	£2,991	€3,440	\$4,188
Group 4	£3,222	€3,706	\$4,511
Group 5	£3,392	€3,901	\$4,749
Group 6	£4,184	€4,812	\$5,858

Product Code: SND/3STR
Description: Three seater

Price	£	€	\$
Group 3	£3,475	€3,997	\$4,865
Group 4	£3,678	€4,230	\$5,150
Group 5	£3,880	€4,462	\$5,432
Group 6	£4,894	€5,629	\$6,852

Dimensions : Height 1,335mm | Width 960/1,600/2,250mm | Depth 800mm | Seat Height 480mm | Weight 68/80/101kg



Product Description: 1, 2 or 3 seater mobile table with plywood frame, laminate top and fully mobile on break loaded casters.

Product Code: TND/1STR
Description: Single seater

Price	£	€	\$
	£1,648	€1,896	\$2,308

Product Code: TND/2STR
Description: Two seater

Price	£	€	\$
	£1,720	€1,978	\$2,408

Product Code: TND/3STR
Description: Three seater

Price	£	€	\$
	£1,976	€2,273	\$2,767

Dimensions : Height 712mm | Width 1,000/1,230/1,750mm | Depth 620mm | Weight 35/40/46kg



Product Description: Low or high media unit with monitor bracket, whiteboard, two laminate topped shelves, integrated power with HDMI port & dual USB and fully mobile on break loaded casters.

Product Code: SND/MEDL
Description: Low media unit with TV bracket and whiteboard

Price	£	€	\$
	£2,757	€3,171	\$3,860

Product Code: SND/MEDH
Description: High media unit with TV bracket and whiteboard

Price	£	€	\$
	£3,046	€3,503	\$4,265

Dimensions : Height 1,149/1,526mm | Width 880mm | Depth 469mm | Weight 34/42kg

Please note: the low media unit can hold up to a 32" screen and the high media unit can hold up to a 42" screen.



Product Description: 2, 4 and 6 Seater Booth configurations.

Product Code: SND/CONFIGA
Description: Two Seater Booth configuration

Price	£	€	\$
Group 3	£9,012	€10,364	\$12,617
Group 4	£9,238	€10,624	\$12,934
Group 5	£9,410	€10,822	\$13,174
Group 6	£10,342	€11,894	\$14,479

Product Code: SND/CONFIGB
Description: Four Seater Booth Configuration

Price	£	€	\$
Group 3	£10,458	€12,027	\$14,642
Group 4	£10,920	€12,558	\$15,288
Group 5	£11,260	€12,949	\$15,764
Group 6	£12,845	€14,772	\$17,983

Product Code: SND/CONFIGC
Description: Six Seater Booth Configuration

Price	£	€	\$
Group 3	£11,682	€13,436	\$16,357
Group 4	£12,087	€13,901	\$16,922
Group 5	£12,492	€14,366	\$17,489
Group 6	£14,520	€16,698	\$20,328

Dimensions : Weight 205/234/282kg



Design by Roger Webb Associates

Table Top Finishes

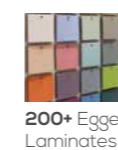

200+ Egger Laminates

Wood



BIRCH



SOLOSCAPE

Product Code: DSO/OFF/OK (Oak Finish) DSO/OFF/BC (Birch Finish)
Description: Office: A boundary defining, single-user workstation with a small footprint, maximising the use of small spaces.

FENIX			MF MDF			Dimensions			
Price	£	€	\$	Price	£	€	\$		
DSO/OFF	£3,614	€4,156	\$5,060	DSO/OFF	£3,364	€3,869	\$4,710	Height	1425mm
								Width	1948mm
								Depth	1800mm
								Weight	131kg



Product Code: DSO/CS4/OK (Oak Finish) DSO/CS4/BC (Birch Finish)
Description: Cross: A multi-station work hub with individual booths allowing spontaneous interactions between users.

FENIX			MF MDF			Dimensions			
Price	£	€	\$	Price	£	€	\$		
DSO/CS4	£3,718	€4,227	\$5,206	DSO/CS4	£3,218	€3,702	\$4,506	Height	1425mm
								Width	1816mm
								Depth	1816mm
								Weight	131kg



Product Code: DSO/FS4/OK (Oak Finish) DSO/FS4/BC (Birch Finish)
Description: Focus: A multi-station work hub offering small or large workspaces for touchdown or longer periods of work.

FENIX			MF MDF			Dimensions			
Price	£	€	\$	Price	£	€	\$		
DSO/FS4	£5,052	€5,810	\$7,073	DSO/FS4	£4,552	€5,235	\$6,373	Height	1425mm
								Width	2172mm
								Depth	1824mm
								Weight	188kg



Product Code: DSO/FSX/OK (Oak Finish) DSO/FSX/BC (Birch Finish)
Description: Focus Extension Kit: Two additional desk positions.

FENIX			MF MDF			Dimensions			
Price	£	€	\$	Price	£	€	\$		
DSO/FSX	£2,683	€3,086	\$3,757	DSO/FSX	£2,433	€2,799	\$3,407	Height	1425mm
								Width	1086mm
								Depth	1824mm
								Weight	99kg



Wood

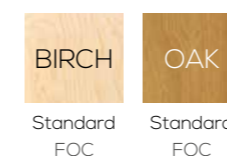
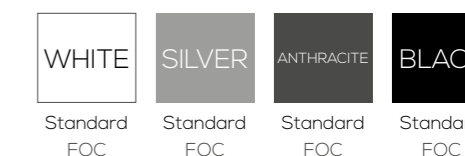

Table Top Finishes



Felt





Product Code: DSO/TD2/OK (Oak Finish) DSO/TD2/BC (Birch Finish)
Description: Touchdown 2 Section: A tessellated arrangement of two opposing desks for touchdown work activities.

FENIX				MF MDF				Dimensions	
Price	£	€	\$	Price	£	€	\$	Height	
DSO/TD2	£2,356	€2,710	\$3,300	DSO/TD2	£2,106	€2,423	\$2,950	Height	1425mm
								Width	2117mm
								Depth	940mm
								Weight	88kg



Product Code: DSO/TD3/OK (Oak Finish) DSO/TD3/BC (Birch Finish)
Description: Touchdown 3 Section: A tessellated arrangement of three opposing desks for touchdown work activities.

FENIX				MF MDF				Dimensions	
Price	£	€	\$	Price	£	€	\$	Height	
DSO/TD3	£3,402	€3,912	\$4,763	DSO/TD3	£3,027	€3,481	\$4,238	Height	1425mm
								Width	2812mm
								Depth	940mm
								Weight	123kg



Product Code: DSO/TDX/OK (Oak Finish) DSO/TDX/BC (Birch Finish)
Description: Touchdown Extension Kit: Two additional desk positions.

FENIX				MF MDF				Dimensions	
Price	£	€	\$	Price	£	€	\$	Height	
DSO/TDX	£2,090	€2,404	\$2,927	DSO/TDX	£1,840	€2,117	\$2,577	Height	1425mm
								Width	1422mm
								Depth	940mm
								Weight	71kg



Power Options

Power Code	Description	Visual	Surface Power (P)			
			Kit Type	£	€	\$
Type I	2 UK fused power sockets		Set of 2	£780	€897	\$1,092
			Set of 3	£1,170	€1,346	\$1,638
			Set of 4	£1,560	€1,794	\$2,184
Type H	1 dual USB charger & 1 UK fused power socket		Set of 2	£840	€966	\$1,176
			Set of 3	£1,260	€1,449	\$1,764
			Set of 4	£1,680	€1,932	\$2,352

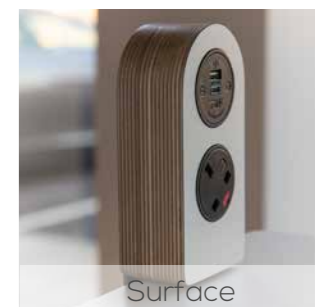

Please note: Power modules are available with both White or Grey laminate finishes.

SOLOSCAPE

Wood

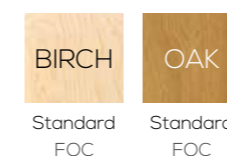

Standard FOC Standard FOC

Table Top Finishes



Standard MF MDF Standard MF MDF Standard MF MDF Standard MF MDF

Felt

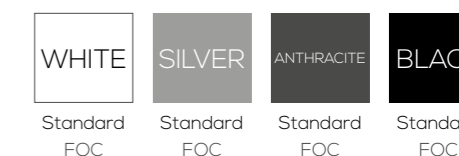

Standard FOC Standard FOC Standard FOC Standard FOC

Flock

90° modular pod, 2 screen high

Booths



Design by Roger Webb Associates

Product Code: FLKCONFIG01

Description: 90° modular pod, 2 screen high. Complementary freestanding tables also available.

Price	£	€	\$	Dimensions	Modules
Group 3	£9,367	€10,773	\$13,114	Height	3 x SFK90DG/FBB2
Group 4	£10,012	€11,514	\$14,017	Width	2600mm
Group 5	£10,817	€12,440	\$15,144	Depth	2400mm
Group 6	£13,234	€15,220	\$18,528	Weight	252kg
Group 7	£14,845	€17,072	\$20,783		



Product Code: FLKCONFIG02

Description: L-shape, 2 screens high. Complementary freestanding tables also available.

Price	£	€	\$	Dimensions	Modules
Group 3	£10,291	€11,835	\$14,408	Height	2 x SFK1200/FBB2
Group 4	£10,888	€12,522	\$15,244	Width	1 x SFK0800/FBB2
Group 5	£11,634	€13,380	\$16,288	Depth	1 x SFKCORN/FBB2
Group 6	£13,873	€15,954	\$19,423	Weight	176kg
Group 7	£15,365	€17,670	\$21,511		



Product Code: FLKCONFIG03

Description: 1200 banquette, 2 screen high. Complementary freestanding tables also available.

Price	£	€	\$	Dimensions	Modules
Group 3	£5,412	€6,224	\$7,577	Height	1 x SFK1200/FBB2
Group 4	£5,706	€6,562	\$7,989	Width	1 x SFK1200/DBB2
Group 5	£6,073	€6,984	\$8,503	Depth	1200mm
Group 6	£7,174	€8,251	\$10,044	Weight	115kg
Group 7	£7,908	€9,095	\$11,072		



Product Code: FLKCONFIG04

Description: U-shape, 2 screens high. Complementary freestanding tables also available.

Price	£	€	\$	Dimensions	Modules
Group 3	£14,489	€16,663	\$20,285	Height	3 x SFK1600/FBB2
Group 4	£15,434	€17,750	\$21,608	Width	2 x SFKCORN/FBB2
Group 5	£16,615	€19,108	\$23,261	Depth	2400mm
Group 6	£20,157	€23,181	\$28,220	Weight	274kg
Group 7	£22,519	€25,897	\$31,527		



Complementing Table Range:

Table Detail	Code	£	€	\$	Weight	Height	Width	Depth
1200 Round Table	TFK1200RND	£775	€892	\$1,085	25	700	1200	1200
900 Square Table	TFK900SQU	£490	€564	\$686	20	700	900	900
800 x 700 Diner Table	TFK800X700	£585	€673	\$819	18	700	800	700
1200 x 700 Diner Table	TFK1200X700	£690	€794	\$966	30	700	1200	700
1600 x 700 Diner Table	TFK1600X700	£954	€1,098	\$1,336	33	700	1600	700

MFC Table Top Finishes



Table Base Finishes



NEW Flock Auditorium



HUDDLE

Product Code: SFKAUD-CONFIGA
Description: Auditorium unit, 16 seat configuration.

Price	£	€	\$	Dimensions	Modules
Group 3	£12,997	€14,947	\$18,196	Height 1077mm	3x SFK60DG/AUDC
Group 4	£13,621	€15,665	\$19,070	Width 3200mm	1 x SFK1200/AUDL
Group 5	£14,400	€16,560	\$20,160	Depth 2796mm	1 x SFK1200/AUDR
Group 6	£16,737	€19,248	\$23,432	Weight 305kg	
Group 7	£18,295	€21,040	\$25,613		

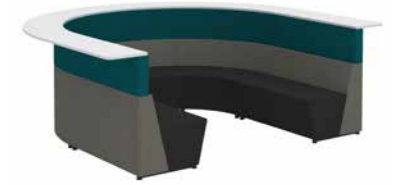

PRESENT

Product Code: SFKAUD-CONFIGB
Description: Auditorium unit, 24 seat configuration.

Price	£	€	\$	Dimensions	Modules
Group 3	£14,042	€16,149	\$19,659	Height 1077mm	2 x SFK90DG/AUDC
Group 4	£14,782	€17,000	\$20,695	Width 4800mm	1 x SFK1200/AUDL
Group 5	£15,707	€18,064	\$21,990	Depth 2796mm	1 x SFK1200/AUDR
Group 6	£18,480	€21,252	\$25,872	Weight 242kg	1 x SFK1600/AUDC
Group 7	£20,329	€23,379	\$28,461		



MEET

Product Code: SFKAUD-CONFIGC
Description: Auditorium unit, 14 seat configuration.

Price	£	€	\$	Dimensions	Modules
Group 3	£10,922	€12,561	\$15,291	Height 1077mm	1 x SFK60DG/AUDL
Group 4	£11,434	€13,150	\$16,008	Width 3200mm	1 x SFK60DG/AUDR
Group 5	£12,073	€13,884	\$16,903	Depth 2380mm	2 x SFK60DG/AUDC
Group 6	£13,992	€16,091	\$19,589	Weight 292kg	
Group 7	£15,271	€17,562	\$21,380		



TOUCHDOWN

Product Code: SFKAUD-CONFIGD
Description: Auditorium unit, 10 seat configuration.

Price	£	€	\$	Dimensions	Modules
Group 3	£8,191	€9,420	\$11,468	Height 1077mm	1 x SFK60DG/AUDL
Group 4	£8,575	€9,862	\$12,005	Width 3200mm	1 x SFK60DG/AUDR
Group 5	£9,055	€10,414	\$12,677	Depth 1600mm	1 x SFK60DG/AUDC
Group 6	£10,494	€12,069	\$14,692	Weight 219kg	
Group 7	£11,453	€13,171	\$16,035		



MFC Table Top Finishes



Table Base Finishes



Hive

1,200mm double booth with integral table



Integrated Power Options

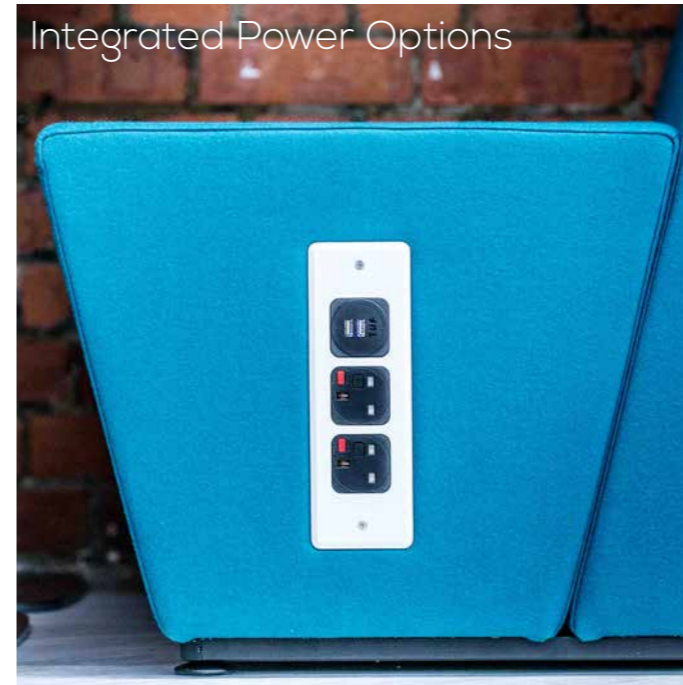

Monitor Bracket



Polished Aluminium or White Legs



Natura or White Workrails



Freestanding Tables



Integrated Tables

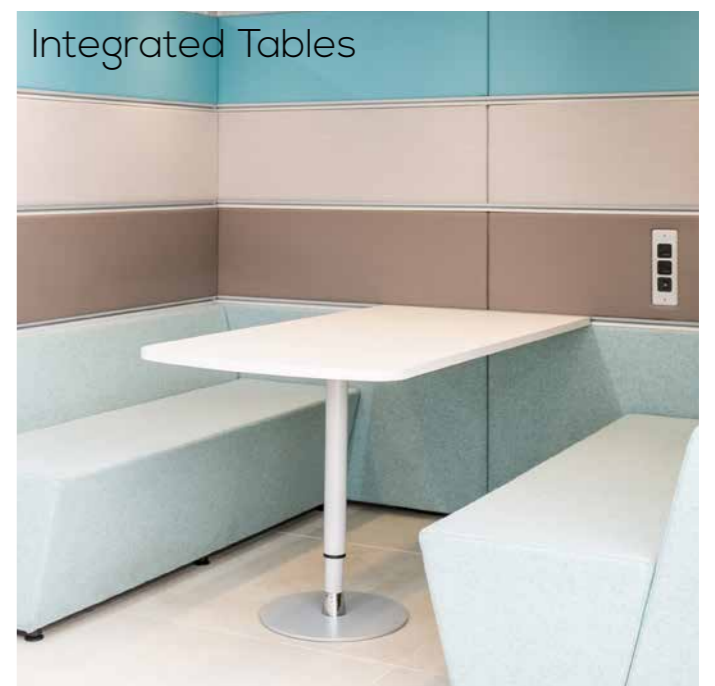

Hive Meeting Pods & Booths

Hive Meeting Pods & Booths



Configuration: HIVECONFIG01
Description: 90° modular pod, 2 screens high with pod table

Modules				Dimensions		
3 x SHF9G, 1 x THV22				Height	1,443mm	
				Width	2,600mm	
				Weight	306kg	
Price				£	€	\$
Group 3				£13,600	€15,039	\$18,311



Configuration: HIVECONFIG24
Description: 90° modular pod & pod table

Modules				Dimensions		
3 x SHF9H, 1 x THV22				Height	1,808mm	
				Width	2,600mm	
				Weight	345kg	
Price				£	€	\$
Group 3				£16,279	€18,003	\$21,917



Configuration: HIVECONFIG22
Description: 90° modular stepped pod with pod table

Modules				Dimensions		
1 x SHF9H, 1 x SHF9G, 1 x SHF9F, 1 x THV22				Height	1,808mm	
				Width	2,600mm	
				Weight	284kg	
Price				£	€	\$
Group 3				£13,923	€15,397	\$18,745



Configuration: HIVECONFIG19
Description: 90° modular pod on legs with pod table

Modules				Dimensions		
3 x SHL1B, 1 x THV22, 2 x SHL17				Height	1,078mm	
				Width	2,600mm	
				Weight	178kg	
Price				£	€	\$
Group 3				£10,264	€11,353	\$13,820

Configuration: HIVECONFIG14
Description: Rectangular pod, 2 screens high, with integrated rectangular pod table

Modules				Dimensions		
1 x SHRB2, 1 x THV17				Height	1,443mm	
				Width	2,400mm	
				Depth	1,700mm	
Price				£	€	\$
Group 3				£11,922	€13,183	\$16,049



Configuration: HIVECONFIG15
Description: Rectangular pod, 3 screens high, with integrated rectangular pod table

Modules				Dimensions		
1 x SHRB3, 1 x THV17				Height	1,808mm	
				Width	2,400mm	
				Depth	1,700mm	
Price				£	€	\$
Group 3				£14,654	€16,204	\$19,726



Configuration: HIVECONFIG25
Description: 1,200mm booth with integral table

Modules				Dimensions		
2 x SHF2G, 1 x THV14				Height	1,443mm	
				Width	2,120mm	
				Depth	1,200mm	
				Weight	127kg	
Price				£	€	\$
Group 3				£6,205	€6,863	\$8,356



Configuration: HIVECONFIG23
Description: 1,200mm double booth with integral table

Modules				Dimensions		
2 x SHF2G, 1 x SHVIN, 2 x THV14				Height	1,443mm	
				Width	4,140mm	
				Depth	1,200mm	
				Weight	205kg	
Price				£	€	\$
Group 3				£10,302	€11,394	\$13,872



Work Rail



Standard FOC Standard FOC

Leg



Standard FOC Standard FOC

Work Surface



Standard FOC Standard FOC Standard FOC

Power



See pg 235

Fabrics



See pg 233

Work Rail



Standard FOC Standard FOC

Leg



Standard FOC Standard FOC

Work Surface

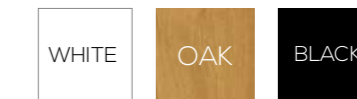

Standard FOC Standard FOC Standard FOC

Power



See pg 235

Fabrics



See pg 233

Hive Collaborative & Learning

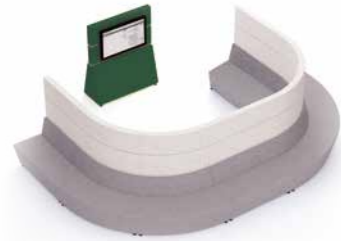

Configuration: HIVECONFIG02
Description: Curved U-shape with free-standing media screen

Modules				Dimensions	
3 x SHVIN, 2 x SHV3N, 1 x SHVIP				Height	1,443mm
				Width	2,600mm
				Depth	3,900mm
				Weight	437kg
Price	£	€	\$		
Group 3	£22,836	€25,252	\$30,743		

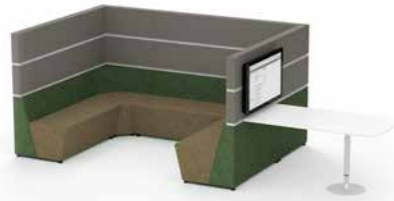

Configuration: HIVECONFIG03
Description: Square U-shape with integral media screen & cantilever table

Modules				Dimensions	
2 x SHF2G, 2 x SHF4G, 1 x SHF2J, 1 x THV3				Height	1,443mm
				Width	4,300mm
				Depth	2,000mm
				Weight	355kg
Price	£	€	\$		
Group 3	£15,707	€17,746	\$21,604		



Configuration: HIVECONFIG09 (with media unit), HIVECONFIG10 (without media unit)
Description: Auditorium unit with freestanding media unit & cantilever table

Modules - HIVECONFIG09		HIVECONFIG10	Dimensions	
1 x SHM10, 1 x SHVIP, 1 x THV16		1 x SHM10	HIVECONFIG09	HIVECONFIG10
			Height	1,078mm
			Width	3,200mm
			Depth	3,320mm
			Weight	408kg
				324kg
Price	HIVECONFIG09	HIVECONFIG10		
Group 3	£13,581	£10,639		
	€14,994	€11,764		
	\$18,254	\$14,321		



Configuration: HIVECONFIG12
Description: S-shape with dual sided benches & pod table

Modules				Dimensions	
2 x SHV3M, 2 x SHV3N, 1 x THV22				Height	1,443mm
				Width	4,400mm
				Depth	3,800mm
				Weight	313kg
Price	£	€	\$		
Group 3	£21,051	€23,278	\$28,340		



Configuration: HIVECONFIG16
Description: 8-shape with pod tables on legs

Modules				Dimensions	
2 x SHL11A, 4 x SHL11B, 2 x THV22, 4 x SHL17				Height	1,078mm
				Width	5,100mm
				Depth	2,600mm
				Weight	565kg
Price	£	€	\$		
Group 3	£19,078	€21,104	\$25,688		

Work Rail

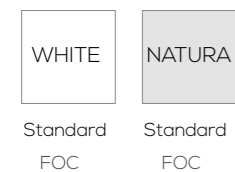

Standard FOC Standard FOC

Leg



Standard FOC Standard FOC

Work Surface

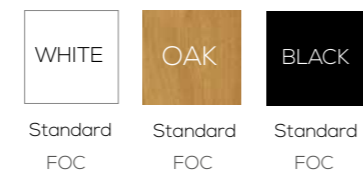

Standard FOC Standard FOC Standard FOC

Power



See pg 235

Fabrics



See pg 233

Hive Lounge & Reception

Configuration: HIVECONFIG05
Description: H-shape with internal benches

Modules				Dimensions	
4 x SHF2E, 2 x SHF6M, 2 x SHV1L				Height	713mm
				Width	4,800mm
				Depth	3,876mm
				Weight	293kg
Price	£	€	\$		
Group 3	£18,986	€21,000	\$25,566		



Configuration: HIVECONFIG17
Description: C-shape on legs

Modules				Dimensions	
2 x SHL11A, 1 x SHL17				Height	713mm
				Width	2,600mm
				Depth	1,300mm
				Weight	124kg
Price	£	€	\$		
Group 3	£4,704	€5,205	\$6,334		



Configuration: HIVECONFIG18
Description: S-shape on legs

Modules				Dimensions	
2 x SHL5A, 2 x SHL14A, 2 x SHL15, 6 x SHL18				Height	713mm
				Width	3,800mm
				Depth	4,300mm
				Weight	448kg
Price	£	€	\$		
Group 3	£15,580	€17,230	\$20,976		



Configuration: HIVECONFIG20
Description: Island unit on legs

Modules				Dimensions	
2 x SHL18, 2 x SHL15, 1 x SHL6A				Height	713mm
				Width	2,920mm
				Depth	1,315mm
				Weight	152kg
Price	£	€	\$		
Group 3	£4,919	€5,440	\$6,623		



Work Rail



Standard FOC Standard FOC

Leg



Standard FOC Standard FOC

Power



See pg 235

Fabrics



See pg 233

Peacework

6 seater booth with integral table



Design by Connection



Solid Oak Legs



Power Options Available

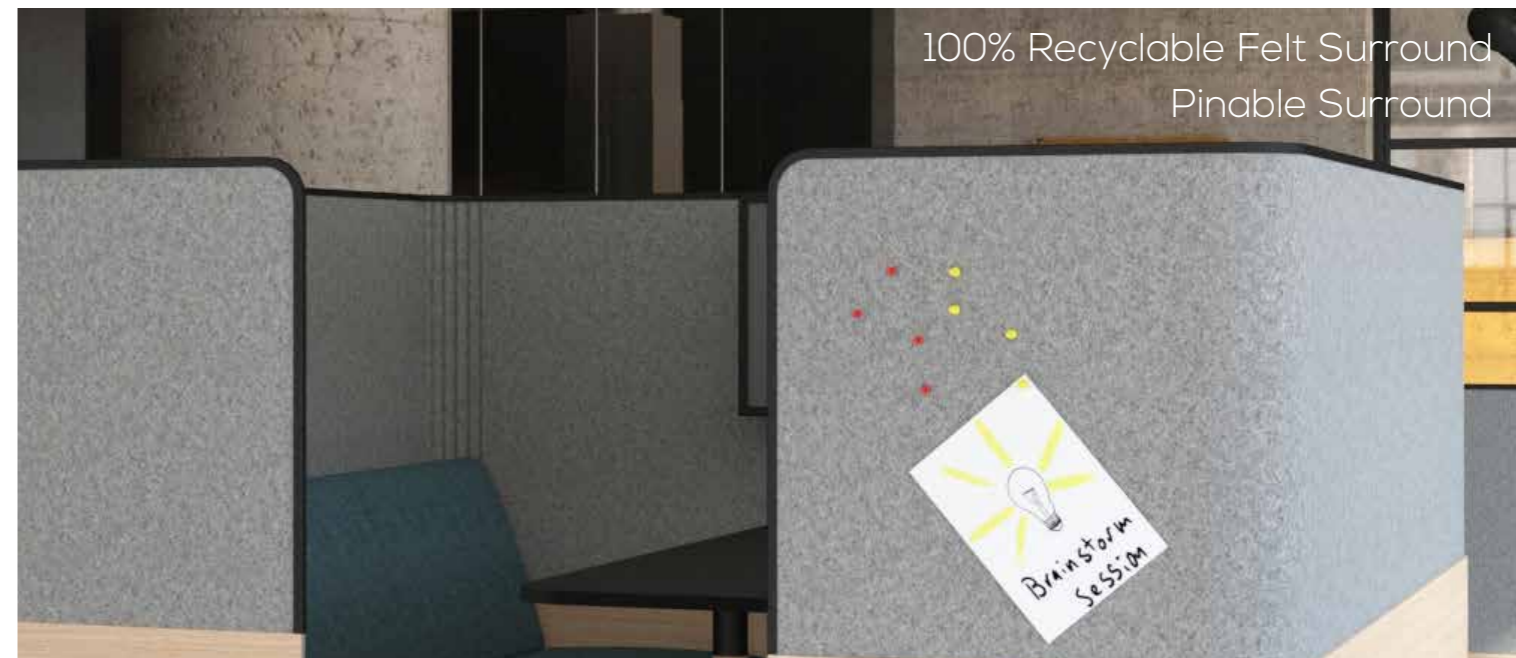

100% Recyclable Felt Surround
Pinable Surround



Product Code: SPW/SSTL (Left) / SPW/SSTR (Right hand pictured)
Description: High back single seat console unit with integrated ambidextrous work surface, PET felt surround with black metal trim and solid oak legs

Price	£	€	\$	Dimensions
Group 3	£3,128	€3,598	\$4,380	Height 1400mm
Group 4	£3,164	€3,639	\$4,430	Width 1200mm
Group 5	£3,208	€3,690	\$4,492	Depth 820mm
Group 6	£3,342	€3,844	\$4,679	Seat Height 450mm
Group 7	£3,431	€3,946	\$4,804	Weight 52kg

Please note: Writing tablets available in white or black laminates



Product Code: SPW/1STR
Description: High back 1-seater sofa with PET felt surround with black metal trim and solid oak legs

Price	£	€	\$	Dimensions
Group 3	£2,754	€3,168	\$3,856	Height 1400mm
Group 4	£2,788	€3,207	\$3,904	Width 840mm
Group 5	£2,831	€3,256	\$3,964	Depth 820mm
Group 6	£2,960	€3,404	\$4,144	Seat Height 450mm
Group 7	£3,046	€3,503	\$4,265	Weight 45kg

Product Code: SPW/2STR
Description: High back 2-seater sofa with PET felt surround with black metal trim and solid oak legs

Price	£	€	\$	Dimensions
Group 3	£3,719	€4,277	\$5,207	Height 1400mm
Group 4	£3,783	€3,783	\$4,351	Width 1520mm
Group 5	£3,863	€4,443	\$5,409	Depth 820mm
Group 6	£4,103	€4,719	\$5,745	Seat Height 450mm
Group 7	£4,263	€4,903	\$5,969	Weight 65kg

Product Code: SPW/3STR
Description: High back 3-seater sofa with integrated work surface, PET felt surround with black metal trim and solid oak legs

Price	£	€	\$	Dimensions
Group 3	£4,706	€5,412	\$6,589	Height 1400mm
Group 4	£4,802	€5,523	\$6,723	Width 2250mm
Group 5	£4,922	€5,661	\$6,891	Depth 800mm
Group 6	£5,282	€6,075	\$7,395	Seat Height 450mm
Group 7	£5,522	€6,351	\$7,731	Weight 85kg

Tablet Surface Finishes



Wood



Fabrics



Felt



See pg 233



Product Code: SPW/2BTM
Description: High back 2-seater booth with integrated work surface, PET felt surround with black metal trim and solid oak legs

Price	£	€	\$	Dimensions
Group 3	£6,437	€7,403	\$9,012	Height 1400mm
Group 4	£6,508	€7,485	\$9,112	Width 2195mm
Group 5	£6,597	€7,587	\$9,236	Depth 840mm
Group 6	£6,864	€7,894	\$9,610	Seat Height 450mm
Group 7	£7,042	€8,099	\$9,859	Weight 110kg

Please select a power option from the table below

Product Code: SPW/4BTM
Description: High back 4-seater booth with integrated work surface, PET felt surround with black metal trim and solid oak legs

Price	£	€	\$	Dimensions
Group 3	£8,582	€9,870	\$12,015	Height 1400mm
Group 4	£8,724	€10,033	\$12,214	Width 2195mm
Group 5	£8,902	€10,238	\$12,463	Depth 1520mm
Group 6	£9,436	€10,852	\$13,211	Seat Height 450mm
Group 7	£9,792	€11,261	\$13,709	Weight 150kg

Please select a power option from the table below

Product Code: SPW/6BTM
Description: High back 6-seater booth with integrated work surface, PET felt surround with black metal trim and solid oak legs

Price	£	€	\$	Dimensions
Group 3	£10,323	€11,872	\$14,453	Height 1400mm
Group 4	£10,515	€12,093	\$14,721	Width 2195mm
Group 5	£10,755	€12,369	\$15,057	Depth 2250mm
Group 6	£11,475	€13,197	\$16,065	Seat Height 450mm
Group 7	£11,955	€13,749	\$16,737	Weight 190kg

Please select a power option from the table below

Power Options (Booths Only)

Power Code	Description	Visual	Surface Power (P)		
			£	€	\$
Type 2 PWPOWPP/2UKBLK/I	1 dual USB charger & 1 UK fused power socket		£364	€419	\$510
Type 3 PWPOWPP/2/UK/BLK/J	2 dual USB charger		£508	€585	\$712

Please note: Power options are positioned 1 above and 1 below the table surface

Tablet Surface Finishes



Wood



Fabrics



Felt



See pg 233

Cubbi Acoustic Booths with 800mm Work Surface

Cubbi Acoustic Booths with 1,200mm Work Surface



Product Code: SCE1A1 (left-handed - pictured), SCE1A4 (right-handed)
Description: Single acoustic booth with 800mm MFC work surface
Certification: BS EN 1021-1:2006. BS EN 1021-2:2006

Price	£	€	\$	Dimensions
Group 3	£4,044	€4,490	\$5,460	Height 1,443mm
Group 4	£4,150	€4,608	\$5,603	Width 1,600mm
Group 5	£4,284	€4,756	\$5,784	Depth 900mm
Group 6	£4,849	€5,383	\$6,547	Weight 155kg



Product Code: SCE1A2
Description: Side-by-side double acoustic booth with 800mm MFC work surface
Certification: BS EN 1021-1:2006. BS EN 1021-2:2006

Price	£	€	\$	Dimensions
Group 3	£6,550	€7,243	\$8,818	Height 1,443mm
Group 4	£6,676	€7,383	\$8,989	Width 1,600mm
Group 5	£6,929	€7,663	\$9,329	Depth 1,700mm
Group 6	£8,003	€8,850	\$10,774	Weight 229kg



Product Code: SCE1A3
Description: Back-to-back double acoustic booth with 800mm MFC work surface
Certification: BS EN 1021-1:2006. BS EN 1021-2:2006

Price	£	€	\$	Dimensions
Group 3	£7,473	€8,265	\$10,061	Height 1,443mm
Group 4	£7,619	€8,425	\$10,256	Width 3,200mm
Group 5	£7,914	€8,752	\$10,654	Depth 900mm
Group 6	£9,167	€10,138	\$12,341	Weight 268kg



Product code: SCE1A5
Description: Quad acoustic booth with 800mm MFC work surface
Certification: BS EN 1021-1:2006. BS EN 1021-2:2006

Price	£	€	\$	Dimensions
Group 3	£11,993	€13,262	\$16,145	Height 1,443mm
Group 4	£12,183	€13,472	\$16,401	Width 3,200mm
Group 5	£12,564	€13,894	\$16,914	Depth 1,700mm
Group 6	£14,182	€15,683	\$19,092	Weight 382kg

Product Code: SCE2A1 (left-handed), SCE2A4 (right-handed- pictured)
Description: Single acoustic booth with 1,200mm MFC work surface
Certification: BS EN 1021-1:2006. BS EN 1021-2:2006

Price	£	€	\$	Dimensions
Group 3	£4,763	€5,288	\$6,431	Height 1,443mm
Group 4	£4,825	€5,357	\$6,515	Width 1,600mm
Group 5	£5,041	€5,597	\$6,806	Depth 1,300mm
Group 6	£5,830	€6,472	\$7,872	Weight 170kg



Product Code: SCE2A2
Description: Side-by-side double acoustic booth with 1,200mm MFC work surface
Certification: BS EN 1021-1:2006. BS EN 1021-2:2006

Price	£	€	\$	Dimensions
Group 3	£7,537	€8,367	\$10,176	Height 1,443mm
Group 4	£7,696	€8,543	\$10,390	Width 1,600mm
Group 5	£8,014	€8,897	\$10,820	Depth 2,500mm
Group 6	£9,365	€10,396	\$12,644	Weight 280kg



Product Code: SCE2A3
Description: Back-to-back double acoustic booth with 1,200mm MFC work surface
Certification: BS EN 1021-1:2006. BS EN 1021-2:2006

Price	£	€	\$	Dimensions
Group 3	£8,519	€9,421	\$11,469	Height 1,443mm
Group 4	£8,672	€9,590	\$11,674	Width 3,200mm
Group 5	£8,975	€9,925	\$12,082	Depth 1,300mm
Group 6	£10,263	€11,349	\$13,816	Weight 291kg



Product code: SCE2A5
Description: Quad acoustic booth with 1,200mm MFC work surface
Certification: BS EN 1021-1:2006. BS EN 1021-2:2006

Price	£	€	\$	Dimensions
Group 3	£12,706	€14,051	\$17,105	Height 1,443mm
Group 4	£12,916	€14,283	\$17,388	Width 3,200mm
Group 5	£13,335	€14,747	\$17,951	Depth 2,500mm
Group 6	£15,116	€16,716	\$20,349	Weight 391kg



Work Rail



Standard FOC Standard FOC

Work Surface



Standard FOC Standard FOC Standard FOC
 Standard

Power Fabrics



See pg 235 See pg 233

Work Rail



Standard FOC Standard FOC

Work Surface



Standard FOC Standard FOC Standard FOC

Power Fabrics



See pg 235 See pg 233

Cubbi Acoustic Booths with Bench & 800mm Work Surface

Cubbi Acoustic Booths with Bench & 1,200mm Work Surface



Product Code: SCE1B1 (left-handed), SCE1B4 (right-handed - pictured)
Description: Single acoustic booth with 800mm MFC work surface & bench
Certification: BS EN 1021-1:2006. BS EN 1021-2:2006

Price	£	€	\$	Dimensions
Group 3	£4,939	€5,483	\$6,668	Height 1,443mm
Group 4	£5,030	€5,584	\$6,792	Width 1,350mm
Group 5	£5,234	€5,811	\$7,067	Depth 900mm
Group 6	£6,045	€6,711	\$8,161	Seat Height 433mm
				Weight 131kg



Product Code: SCE1B2
Description: Side-by-side double acoustic booth with 800mm MFC work surface & bench
Certification: BS EN 1021-1:2006. BS EN 1021-2:2006

Price	£	€	\$	Dimensions
Group 3	£7,941	€8,782	\$10,691	Height 1,443mm
Group 4	£8,076	€8,932	\$10,873	Width 1,350mm
Group 5	£8,346	€9,229	\$11,236	Depth 1,700mm
Group 6	£9,491	€10,495	\$12,776	Seat Height 433mm
				Weight 260kg



Product Code: SCE1B3
Description: Back-to-back double acoustic booth with 800mm MFC work surface & bench
Certification: BS EN 1021-1:2006. BS EN 1021-2:2006

Price	£	€	\$	Dimensions
Group 3	£8,654	€9,607	\$11,684	Height 1,443mm
Group 4	£8,813	€9,784	\$11,899	Width 2,700mm
Group 5	£9,131	€10,137	\$12,328	Depth 900mm
Group 6	£10,483	€11,637	\$14,153	Seat Height 433mm
				Weight 257kg



Product code: SCE1B5
Description: Quad acoustic booth with 800mm MFC work surface & bench
Certification: BS EN 1021-1:2006. BS EN 1021-2:2006

Price	£	€	\$	Dimensions
Group 3	£13,574	€15,011	\$18,273	Height 1,443mm
Group 4	£13,765	€15,222	\$18,531	Width 2,700mm
Group 5	£14,146	€15,642	\$19,043	Depth 1,700mm
Group 6	£15,764	€17,432	\$21,221	Seat Height 433mm
				Weight 380kg

Product Code: SCE2B1 (left-handed- pictured), SCE2B4 (right-handed)
Description: Single acoustic booth with 1,200mm MFC work surface & bench
Certification: BS EN 1021-1:2006. BS EN 1021-2:2006

Price	£	€	\$	Dimensions
Group 3	£5,617	€6,212	\$7,562	Height 1,443mm
Group 4	£5,741	€6,350	\$7,730	Width 1,350mm
Group 5	£6,065	€6,707	\$8,165	Depth 1,300mm
Group 6	£7,344	€8,121	\$9,887	Seat Height 433mm
				Weight 171kg



Product Code: SCE2B2
Description: Side-by-side double acoustic booth with 1,200mm MFC work surface & bench
Certification: BS EN 1021-1:2006. BS EN 1021-2:2006

Price	£	€	\$	Dimensions
Group 3	£8,945	€9,892	\$12,042	Height 1,443mm
Group 4	£9,113	€10,078	\$12,269	Width 1,350mm
Group 5	£9,450	€10,450	\$12,722	Depth 2,500mm
Group 6	£10,882	€12,034	\$14,650	Seat Height 433mm
				Weight 277kg



Product Code: SCE2B3
Description: Back-to-back double acoustic booth with 1,200mm MFC work surface & bench
Certification: BS EN 1021-1:2006. BS EN 1021-2:2006

Price	£	€	\$	Dimensions
Group 3	£9,734	€10,806	\$13,142	Height 1,443mm
Group 4	£9,912	€11,003	\$13,382	Width 2,700mm
Group 5	£10,266	€11,396	\$13,860	Depth 1,300mm
Group 6	£11,768	€13,064	\$15,888	Seat Height 433mm
				Weight 273kg



Product code: SCE2B5
Description: Quad acoustic booth with 1,200mm MFC work surface & bench
Certification: BS EN 1021-1:2006. BS EN 1021-2:2006

Price	£	€	\$	Dimensions
Group 3	£15,347	€17,036	\$20,720	Height 1,443mm
Group 4	£15,587	€17,303	\$21,043	Width 2,700mm
Group 5	£16,068	€17,836	\$21,693	Depth 2,500mm
Group 6	£18,108	€20,101	\$24,446	Seat Height 433mm
				Weight 464kg

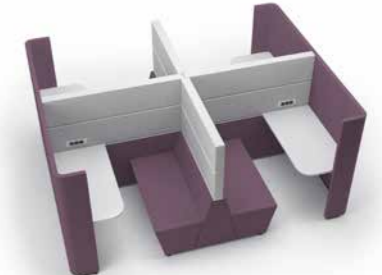

Work Rail



Standard FOC Standard FOC

Work Surface



Standard FOC Standard FOC Standard FOC

Power Fabrics



See pg 235 See pg 233

Work Rail



Standard FOC Standard FOC

Work Surface



Standard FOC Standard FOC Standard FOC

Power Fabrics



See pg 235 See pg 233

Cubbi

Single acoustic booth

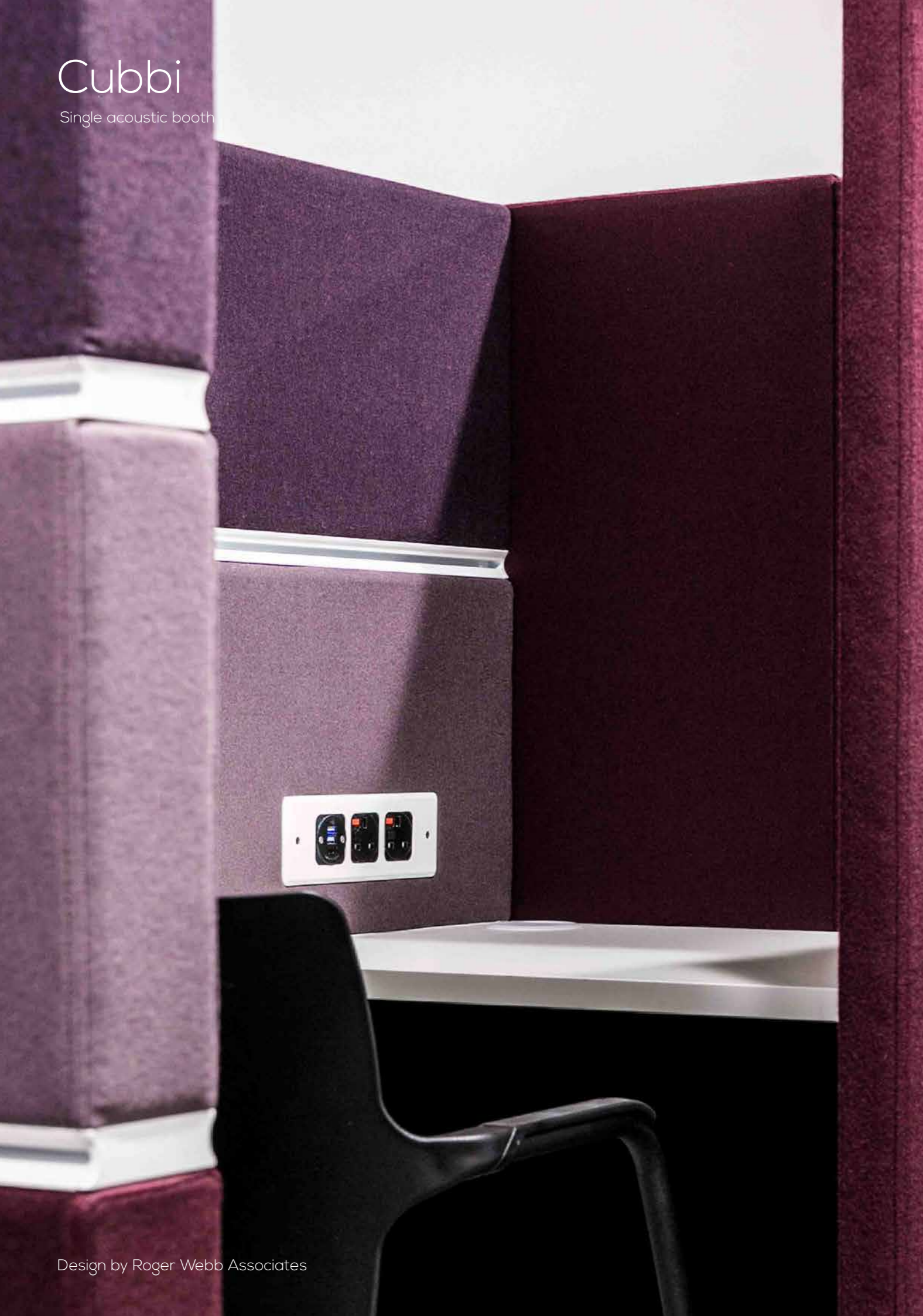

Design by Roger Webb Associates

Hygge

Hygge chairs with Omni table



Design by David Fox Design

Hygge

Low & high back lounge chairs with Omni table

Statement Chairs

Hygge Low Back



Product Code: SHG1

Description: Low back lounge chair with oak veneer shell and solid oak 4 leg base. Black and Wenge stained options also available

Price	£	€	\$	Dimensions	
Group 3	£1,241	€1,374	\$1,672	Height	780mm
Group 4	£1,267	€1,402	\$1,707	Width	730mm
Group 5	£1,319	€1,460	\$1,777	Depth	690mm
Group 6	£1,542	€1,706	\$2,077	Seat Height	400mm
Group 7	£1,634	€1,808	\$2,201	Weight	14kg
Black Stained Oak	+£326	+€363	+£442		
Wenge Stained Oak	+£326	+€363	+£442		



Product Code: SHG2

Description: Low back lounge chair with oak veneer shell and solid oak broomstick swivel base. Black and Wenge stained options also available

Price	£	€	\$	Dimensions	
Group 3	£1,319	€1,465	\$1,782	Height	780mm
Group 4	£1,348	€1,498	\$1,821	Width	730mm
Group 5	£1,402	€1,557	\$1,894	Depth	690mm
Group 6	£1,636	€1,817	\$2,210	Seat Height	400mm
Group 7	£1,732	€1,924	\$2,340	Weight	17kg
Black Stained Oak	+£326	+€363	+£442		
Wenge Stained Oak	+£326	+€363	+£442		



Matching Table:

Omni [pg 142](#)

Wood

OAK	BLACK STAINED OAK	WENGE STAINED OAK
Standard FOC	Special	Special

Fabrics



See pg 233

Hygge

High back rocking chair



Design by David Fox Design

Statement Chairs

Hygge High Back

Product Code: SHG3

Description: High back lounge chair with oak veneer shell and solid oak 4 leg base. Black and Wenge stained options also available

Price	£	€	\$	Dimensions
Group 3	£1,422	€1,574	\$1,915	Height 1,150mm
Group 4	£1,452	€1,607	\$1,956	Width 875mm
Group 5	£1,511	€1,672	\$2,035	Depth 775mm
Group 6	£1,768	€1,955	\$2,381	Seat Height 400mm
Group 7	£1,873	€2,072	\$2,522	Weight 17kg
Black Stained Oak	+£326	+€363	+£442	
Wenge Stained Oak	+£326	+€363	+£442	



Product Code: SHG4

Description: High back lounge chair with oak veneer shell and solid oak broomstick swivel base. Black and Wenge stained options also available

Price	£	€	\$	Dimensions
Group 3	£1,512	€1,679	\$2,042	Height 1,150mm
Group 4	£1,544	€1,715	\$2,085	Width 875mm
Group 5	£1,607	€1,785	\$2,170	Depth 775mm
Group 6	£1,874	€2,081	\$2,531	Seat Height 400mm
Group 7	£1,985	€2,204	\$2,681	Weight 20kg
Black Stained Oak	+£326	+€363	+£442	
Wenge Stained Oak	+£326	+€363	+£442	



Product Code: SHG5A

Description: High back rocking chair with oak veneer shell and solid oak runner legs. Black and Wenge stained options also available

Price	£	€	\$	Dimensions
Group 3	£2,131	€2,452	\$2,984	Height 1,130mm
Group 4	£2,160	€2,485	\$3,025	Width 875mm
Group 5	£2,220	€2,554	\$3,109	Depth 775mm
Group 6	£2,476	€2,848	\$3,468	Seat Height 446mm
Group 7	£2,581	€2,969	£3,615	Weight 20kg
Black Stained Oak	+£326	+€363	+£442	
Wenge Stained Oak	+£326	+€363	+£442	



Matching Table:

Omni [pg 142](#)

Wood

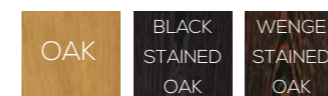

Standard
FOC

Special

Special

Fabrics



See pg 233

Muse

High back privacy booth



Design by Hilary Birkbeck

Statement Chairs

Muse Privacy Booth

Product Code: SMSIE

Description: High back privacy booth with chrome effect frame.

Price	£	€	\$	Dimensions	
Group 3	£2,162	€2,487	\$3,027	Height	1,480mm
Group 4	£2,262	€2,602	\$3,167	Width	900mm
Group 5	£2,387	€2,746	\$3,342	Depth	820mm
Group 6	£2,762	€3,177	\$3,867	Seat Height	480mm
Group 7	£3,012	€3,464	\$4,217	Weight	40kg

Additional Options:	£	€	\$
Writing Tablet	+£313	+€360	+\$438



Writing Tablet

Product Code: SMSIA

Description: High back privacy booth with solid oak frame. Black and Wenge stained options also available.

Price	£	€	\$	Dimensions	
Group 3	£2,693	€3,097	\$3,771	Height	1,460mm
Group 4	£2,793	€3,212	\$3,911	Width	900mm
Group 5	£2,918	€3,356	\$4,086	Depth	820mm
Group 6	£3,293	€3,787	\$4,611	Seat Height	470mm
Group 7	£3,543	€4,075	\$4,961	Weight	36kg

Additional Options:	£	€	\$
Writing Tablet	+£313	+€360	+\$438
Black or Wenge Stained Finishes	+£160	+€184	+\$224



Writing Tablet

Metal



Standard FOC Special FOC

Wood

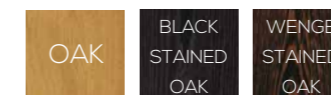

Standard FOC Special Special

Tablet Surface Finishes

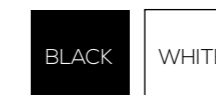

Standard FOC

Fabrics



See pg 233

Dixi

Wing back & high back chairs with Dixi table



Statement Chairs

Dixi Upholstered

Product Code: SDX3 (fixed base), SDX4 (swivel base)
Description: Low back tub chair with fully upholstered fixed or swivel base
Certification: BS EN 16139: 2013 Level 1. BS EN 1021-1:2006. BS EN 1021-2:2006

Price - SDX3				Price - SDX4				Dimensions	
Group	£	€	\$	Group	£	€	\$	Height	
Group 3	£1,130	€1,251	\$1,522	Group 3	£1,402	€1,551	\$1,888	780mm	
Group 4	£1,167	€1,291	\$1,571	Group 4	£1,438	€1,591	\$1,937	835mm	
Group 5	£1,239	€1,370	\$1,668	Group 5	£1,510	€1,670	\$2,033	770mm	
Group 6	£1,549	€1,713	\$2,085	Group 6	£1,820	€2,013	\$2,450	440mm	
Group 7	£1,870	€2,068	\$2,518	Group 7	£2,170	€2,401	\$2,922	28kg (SDX3) 43kg (SDX4)	



Product Code: SDX1 (fixed base), SDX2 (swivel base)
Description: Wing back tub chair with fully upholstered fixed or swivel base
Certification: BS EN 16139: 2013 Level 1. BS EN 1021-1:2006. BS EN 1021-2:2006

Price - SDX1				Price - SDX2				Dimensions	
Group	£	€	\$	Group	£	€	\$	Height	
Group 3	£1,296	€1,433	\$1,745	Group 3	£1,567	€1,734	\$2,110	1100mm	
Group 4	£1,347	€1,490	\$1,813	Group 4	£1,618	€1,790	\$2,179	830mm	
Group 5	£1,450	€1,604	\$1,952	Group 5	£1,721	€1,904	\$2,317	770mm	
Group 6	£1,883	€2,083	\$2,536	Group 6	£2,155	€2,383	\$2,901	440mm	
Group 7	£2,062	€2,281	\$2,777	Group 7	£2,334	€2,581	\$3,142	33kg (SDX1) 48kg (SDX2)	



Product Code: SDX5 (fixed base), SDX6 (swivel base)
Description: High back tub chair with headrest and fully upholstered fixed or swivel base
Certification: BS EN 16139: 2013 Level 1. BS EN 1021-1:2006. BS EN 1021-2:2006

Price - SDX5				Price - SDX6				Dimensions	
Group	£	€	\$	Group	£	€	\$	Height	
Group 3	£1,496	€1,654	\$2,014	Group 3	£1,767	€1,954	\$2,379	1200mm	
Group 4	£1,546	€1,711	\$2,082	Group 4	£1,817	€2,010	\$2,446	830mm	
Group 5	£1,648	€1,823	\$2,219	Group 5	£1,919	€2,122	\$2,583	770mm	
Group 6	£2,082	€2,303	\$2,803	Group 6	£2,355	€2,604	\$3,170	440mm	
Group 7	£2,702	€2,988	\$3,638	Group 7	£3,127	€3,459	\$4,210	35kg (SDX5) 50kg (SDX6)	



Fabrics



See pg 233

Dixi Cage



Product Code: SDX8/A
Description: Low back tub chair with chrome, black or copper metal effect cage base
Certification: BS EN 16139: 2013 Level 1. BS EN 1021-1:2006. BS EN 1021-2:2006

Price	£	€	\$	Dimensions
Group 3	£1,297	€1,435	\$1,746	Height 780mm
Group 4	£1,326	€1,467	\$1,785	Width 830mm
Group 5	£1,384	€1,531	\$1,864	Depth 770mm
Group 6	£1,630	€1,803	\$2,194	Seat Height 440mm
Group 7	£1,731	€1,914	\$2,330	Weight 27kg



Product Code: SDX7/A
Description: Wing back tub chair with chrome, black or copper metal effect cage base
Certification: BS EN 16139: 2013 Level 1. BS EN 1021-1:2006. BS EN 1021-2:2006

Price	£	€	\$	Dimensions
Group 3	£1,522	€1,683	\$2,049	Height 1100mm
Group 4	£1,564	€1,730	\$2,106	Width 830mm
Group 5	£1,648	€1,823	\$2,219	Depth 770mm
Group 6	£2,008	€2,221	\$2,704	Seat Height 440mm
Group 7	£2,156	€2,384	\$2,903	Weight 42kg



Product Code: SDX9/A
Description: High back tub chair with headrest and chrome, black or copper metal effect cage base
Certification: BS EN 16139: 2013 Level 1. BS EN 1021-1:2006. BS EN 1021-2:2006

Price	£	€	\$	Dimensions
Group 3	£1,672	€1,850	\$2,252	Height 1,200mm
Group 4	£1,716	€1,898	\$2,310	Width 830mm
Group 5	£1,805	€1,997	\$2,431	Depth 770mm
Group 6	£2,184	€2,415	\$2,940	Seat Height 440mm
Group 7	£2,340	€2,588	\$3,150	Weight 32kg

Special Options	£	€	\$
Warm Metallic Copper Base	+£78	+€87	+\$122

Matching Table:
 Dixi Cage [pg 142](#)

Metal

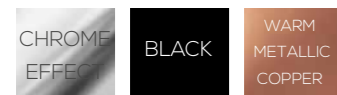

Standard FOC Special FOC Special

Fabrics



See pg 233

Dixi Wooden



Product Code: SDX8/B
Description: Low back tub chair with solid oak 4 leg base. Black and Wenge stained and Walnut options also available
Certification: BS EN 16139: 2013 Level 1. BS EN 1021-1:2006. BS EN 1021-2:2006

Price	£	€	\$	Dimensions
Group 3	£1,404	€1,553	\$1,890	Height 780mm
Group 4	£1,433	€1,585	\$1,930	Width 830mm
Group 5	£1,490	€1,648	\$2,007	Depth 770mm
Group 6	£1,737	€1,921	\$2,338	Seat Height 440mm
Group 7	£1,838	€2,033	\$2,474	Weight 28kg

Product Code: SDX7/B
Description: Wing back tub chair with solid oak 4 leg base. Black and Wenge stained and Walnut options also available.
Certification: BS EN 16139: 2013 Level 1. BS EN 1021-1:2006. BS EN 1021-2:2006

Price	£	€	\$	Dimensions
Group 3	£1,628	€1,800	\$2,191	Height 1100mm
Group 4	£1,669	€1,846	\$2,247	Width 830mm
Group 5	£1,754	€1,941	\$2,362	Depth 770mm
Group 6	£2,113	€2,337	\$2,845	Seat Height 440mm
Group 7	£2,262	€2,502	\$3,045	Weight 43kg

Product Code: SDX9/B
Description: High back tub chair with headrest and solid oak 4 leg base. Black and Wenge stained and Walnut options also available
Certification: BS EN 16139: 2013 Level 1. BS EN 1021-1:2006. BS EN 1021-2:2006

Price	£	€	\$	Dimensions
Group 3	£1,778	€1,967	\$2,394	Height 1,200mm
Group 4	£1,823	€2,016	\$2,455	Width 830mm
Group 5	£1,913	€2,115	\$2,575	Depth 770mm
Group 6	£2,291	€2,534	\$3,085	Seat Height 440mm
Group 7	£2,446	€2,705	\$3,293	Weight 33kg

Special Options	£	€	\$
Black Stained Oak	+£130	+€145	+\$176
Wenge Stained Oak	+£130	+€145	+\$176
Walnut	+£394	+€435	+\$530

Matching Table:
 Dixi Wooden [pg 142](#)

Wood

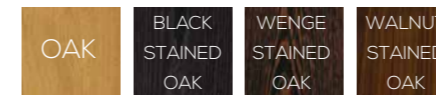

Standard FOC Special Special Special

Fabrics



See pg 233

Mae Metal



Product Code: SME2D
Description: Medium back armchair with chrome effect or black metal 4 star fixed base
Certification: BS EN 16139:2013 Level 1. BS EN 1021-1:2006. BS EN 1021-2:2006

Price	£	€	\$	Price	£	€	\$	Dimensions
Group 3	£1,076	€1,191	\$1,449	Leather 1	£1,291	€1,429	\$1,739	Height 910mm
Group 4	£1,103	€1,220	\$1,486	Leather 2	£1,457	€1,612	\$1,962	Width 770mm
Group 5	£1,157	€1,281	\$1,559	Leather 3	£1,623	€1,796	\$2,186	Depth 740mm
Group 6	£1,385	€1,533	\$1,865					Seat Height 430mm
Group 7	£1,480	€1,637	\$1,993					Weight 24kg



Product Code: SME2A
Description: Medium back armchair with chrome effect or black metal 4 star swivel base
Certification: BS EN 16139:2013 Level 1. BS EN 1021-1:2006. BS EN 1021-2:2006

Price	£	€	\$	Price	£	€	\$	Dimensions
Group 3	£1,134	€1,255	\$1,528	Leather 1	£1,350	€1,494	\$1,819	Height 910mm
Group 4	£1,162	€1,286	\$1,565	Leather 2	£1,517	€1,679	\$2,043	Width 770mm
Group 5	£1,217	€1,346	\$1,639	Leather 3	£1,683	€1,862	\$2,267	Depth 740mm
Group 6	£1,444	€1,598	\$1,945					Seat Height 430mm
Group 7	£1,539	€1,703	\$2,073					Weight 24kg



Product Code: SME1D
Description: High back armchair with chrome effect or black metal 4 star fixed base
Certification: BS EN 16139:2013 Level 1. BS EN 1021-1:2006. BS EN 1021-2:2006

Price	£	€	\$	Dimensions
Group 3	£1,250	€1,383	\$1,684	Height 1160mm
Group 4	£1,282	€1,418	\$1,726	Width 770mm
Group 5	£1,342	€1,485	\$1,807	Depth 740mm
Group 6	£1,604	€1,775	\$2,160	Seat Height 430mm
Group 7	£1,712	€1,894	\$2,305	Weight 26kg



Product Code: SME1A
Description: High back armchair with chrome effect or black metal 4 star swivel base
Certification: BS EN 16139:2013 Level 1. BS EN 1021-1:2006. BS EN 1021-2:2006

Price	£	€	\$	Dimensions
Group 3	£1,311	€1,451	\$1,765	Height 1160mm
Group 4	£1,340	€1,482	\$1,804	Width 770mm
Group 5	£1,402	€1,551	\$1,888	Depth 740mm
Group 6	£1,662	€1,839	\$2,239	Seat Height 430mm
Group 7	£1,771	€1,959	\$2,385	Weight 26kg

Matching Tables:
 Gloss [pg 143](#)

Metal



Standard FOC Special FOC

Fabrics



See pg 233

Mae Wooden

Product Code: SME2G
Description: Medium back armchair with oak-stained beech 4 leg base.
Certification: BS EN 16139:2013 Level 1. BS EN 1021-1:2006. BS EN 1021-2:2006

Price	£	€	\$	Price	£	€	\$	Dimensions
Group 3	£1,093	€1,210	\$1,472	Leather 1	£1,309	€1,449	\$1,762	Height 910mm
Group 4	£1,120	€1,239	\$1,508	Leather 2	£1,474	€1,630	\$1,984	Width 770mm
Group 5	£1,173	€1,298	\$1,580	Leather 3	£1,641	€1,815	\$2,209	Depth 740mm
Group 6	£1,402	€1,551	\$1,888					Seat Height 430mm
Group 7	£1,496	€1,655	\$2,014					Weight 24kg



Product Code: SME1G
Description: High back armchair with oak-stained beech 4 leg base.
Certification: BS EN 16139:2013 Level 1. BS EN 1021-1:2006. BS EN 1021-2:2006

Price	£	€	\$	Dimensions
Group 3	£1,267	€1,402	\$1,706	Height 1160mm
Group 4	£1,298	€1,437	\$1,749	Width 770mm
Group 5	£1,360	€1,505	\$1,832	Depth 740mm
Group 6	£1,622	€1,795	\$2,184	Seat Height 430mm
Group 7	£1,729	€1,914	\$2,329	Weight 26kg



Product Code: SME2M
Description: Medium back armchair with black-stained beech 4 leg base.
Certification: BS EN 16139:2013 Level 1. BS EN 1021-1:2006. BS EN 1021-2:2006

Price	£	€	\$	Price	£	€	\$	Dimensions
Group 3	£1,093	€1,214	\$1,476	Leather 1	£1,309	€1,453	\$1,768	Height 910mm
Group 4	£1,120	€1,244	\$1,512	Leather 2	£1,474	€1,637	\$1,990	Width 770mm
Group 5	£1,173	€1,303	\$1,584	Leather 3	£1,641	€1,822	\$2,216	Depth 740mm
Group 6	£1,402	€1,557	\$1,893					Seat Height 430mm
Group 7	£1,496	€1,661	\$2,020					Weight 24kg



Product Code: SME1M
Description: High back armchair with black-stained beech 4 leg base.
Certification: BS EN 16139:2013 Level 1. BS EN 1021-1:2006. BS EN 1021-2:2006

Price	£	€	\$	Dimensions
Group 3	£1,267	€1,407	\$1,711	Height 1160mm
Group 4	£1,298	€1,441	\$1,753	Width 770mm
Group 5	£1,360	€1,510	\$1,836	Depth 740mm
Group 6	£1,622	€1,801	\$2,190	Seat Height 430mm
Group 7	£1,729	€1,920	\$2,335	Weight 26kg



Wood



Standard FOC Special FOC

Fabrics



See pg 233

Ark



Product Code: SAR/UPH/OAK

Description: Medium back armchair with solid oak 4 leg base. Black and Wenge stained options also available



Price	£	€	\$	Price	£	€	\$
Group 0	£992	€1,141	\$1,389	Group 4	£1,156	€1,330	\$1,619
Group 1	£1,027	€1,181	\$1,438	Group 5	£1,215	€1,398	\$1,701
Group 2	£1,074	€1,236	\$1,504	Group 6	£1,391	€1,600	\$1,948
Group 3	£1,109	€1,276	\$1,553	Group 7	£1,509	€1,735	\$2,113

Dimensions

Height	1,090mm
Width	740mm
Depth	800mm
Seat Height	455mm
Weight	19kg

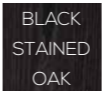

Wood

		
OAK	BLACK STAINED OAK	WENGE STAINED OAK
Standard	Standard	Standard
FOC	FOC	FOC

Fabrics



See pg 233

Kala Metal



Product Code: SKL2A
Description: Low back armchair with a chrome effect or black metal wire base
Certification: BS EN 1021-1:2006. BS EN 1021-2:2006

Price	£	€	\$	Price	£	€	\$	Dimensions
Group 0	£759	€840	\$1,023	Group 6	£1,134	€1,255	\$1,528	Height 740mm
Group 1	£782	€866	\$1,054	Group 7	£1,221	€1,352	\$1,645	Width 751mm
Group 2	£814	€900	\$1,096	Leather 1	£1,049	€1,162	\$1,413	Depth 695mm
Group 3	£856	€947	\$1,153	Leather 2	£1,200	€1,328	\$1,616	Seat Height 400mm
Group 4	£881	€975	\$1,187	Leather 3	£1,350	€1,494	\$1,818	Weight 17kg
Group 5	£929	€1,028	\$1,251					



Product Code: SKL1A
Description: High back armchair with a chrome effect or black metal wire base
Certification: BS EN 1021-1:2006. BS EN 1021-2:2006

Price	£	€	\$	Price	£	€	\$	Dimensions
Group 0	£810	€896	\$1,090	Group 6	£1,310	€1,450	\$1,764	Height 898mm
Group 1	£834	€923	\$1,124	Group 7	£1,423	€1,575	\$1,917	Width 729mm
Group 2	£882	€976	\$1,188	Leather 1	£1,172	€1,297	\$1,578	Depth 780mm
Group 3	£939	€1,040	\$1,265	Leather 2	£1,372	€1,518	\$1,848	Seat Height 400mm
Group 4	£971	€1,074	\$1,308	Leather 3	£1,573	€1,740	\$2,119	Weight 19kg
Group 5	£1,035	€1,145	\$1,394					



Product code: SKL2C
Description: Low back armchair with a chrome effect or black metal 4 star swivel base
Certification: BS EN 1021-1:2006. BS EN 1021-2:2006

Price	£	€	\$	Price	£	€	\$	Dimensions
Group 0	£898	€994	\$1,209	Group 6	£1,275	€1,411	\$1,717	Height 740mm
Group 1	£923	€1,021	\$1,243	Group 7	£1,360	€1,504	\$1,831	Width 751mm
Group 2	£952	€1,054	\$1,282	Leather 1	£1,190	€1,316	\$1,602	Depth 695mm
Group 3	£995	€1,101	\$1,340	Leather 2	£1,340	€1,482	\$1,804	Seat Height 400mm
Group 4	£1,020	€1,129	\$1,374	Leather 3	£1,490	€1,649	\$2,007	Weight 20kg
Group 5	£1,069	€1,183	\$1,440					



Product Code: SKL1C
Description: High back armchair with a chrome effect or black metal 4 star swivel base
Certification: BS EN 1021-1:2006. BS EN 1021-2:2006

Price	£	€	\$	Price	£	€	\$	Dimensions
Group 0	£925	€1,023	\$1,246	Group 6	£1,417	€1,568	\$1,909	Height 898mm
Group 1	£948	€1,049	\$1,277	Group 7	£1,529	€1,692	\$2,059	Width 729mm
Group 2	£997	€1,104	\$1,343	Leather 1	£1,282	€1,419	\$1,726	Depth 780mm
Group 3	£1,051	€1,163	\$1,415	Leather 2	£1,479	€1,636	\$1,991	Seat Height 400mm
Group 4	£1,084	€1,199	\$1,460	Leather 3	£1,674	€1,851	\$2,254	Weight 22kg
Group 5	£1,146	€1,268	\$1,544					

Matching Tables:
 Gloss [pg 143](#)

Metal



Fabrics



See pg 233

Kala Wooden



Product Code: SKL2G
Description: Low back armchair with solid oak 4 leg base. Black and Wenge stained options also available
Certification: BS EN 1021-1:2006. BS EN 1021-2:2006

Price	£	€	\$	Price	£	€	\$	Dimensions
Group 0	£936	€1,036	\$1,261	Group 6	£1,438	€1,591	\$1,937	Height 740mm
Group 1	£969	€1,072	\$1,305	Group 7	£1,551	€1,716	\$2,089	Width 751mm
Group 2	£1,009	€1,117	\$1,359	Leather 1	£1,324	€1,465	\$1,783	Depth 695mm
Group 3	£1,066	€1,180	\$1,436	Leather 2	£1,524	€1,686	\$2,053	Seat Height 400mm
Group 4	£1,099	€1,216	\$1,480	Leather 3	£1,723	€1,906	\$2,320	Weight 14kg
Group 5	£1,164	€1,288	\$1,568	Black Stained Oak	+£130	+€145	+\$176	
				Wenge Stained Oak	+£130	+€145	+\$176	

Product Code: SKL1G
Description: High back armchair with solid oak 4 leg base. Black and Wenge stained options also available
Certification: BS EN 1021-1:2006. BS EN 1021-2:2006

Price	£	€	\$	Price	£	€	\$	Dimensions
Group 0	£1,020	€1,129	\$1,374	Group 6	£1,520	€1,681	\$2,047	Height 898mm
Group 1	£1,051	€1,163	\$1,415	Group 7	£1,632	€1,805	\$2,198	Width 729mm
Group 2	£1,091	€1,208	\$1,470	Leather 1	£1,408	€1,557	\$1,896	Depth 780mm
Group 3	£1,148	€1,270	\$1,546	Leather 2	£1,607	€1,778	\$2,164	Seat Height 400mm
Group 4	£1,180	€1,306	\$1,589	Leather 3	£1,807	€1,999	\$2,433	Weight 16kg
Group 5	£1,245	€1,378	\$1,678	Black Stained Oak	+£130	+€145	+\$176	
				Wenge Stained Oak	+£130	+€145	+\$176	



Metal



Wood

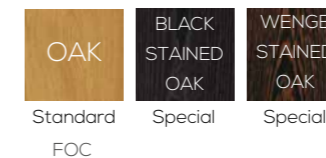

Fabrics



See pg 233

Pear

Lounge chair with metal base

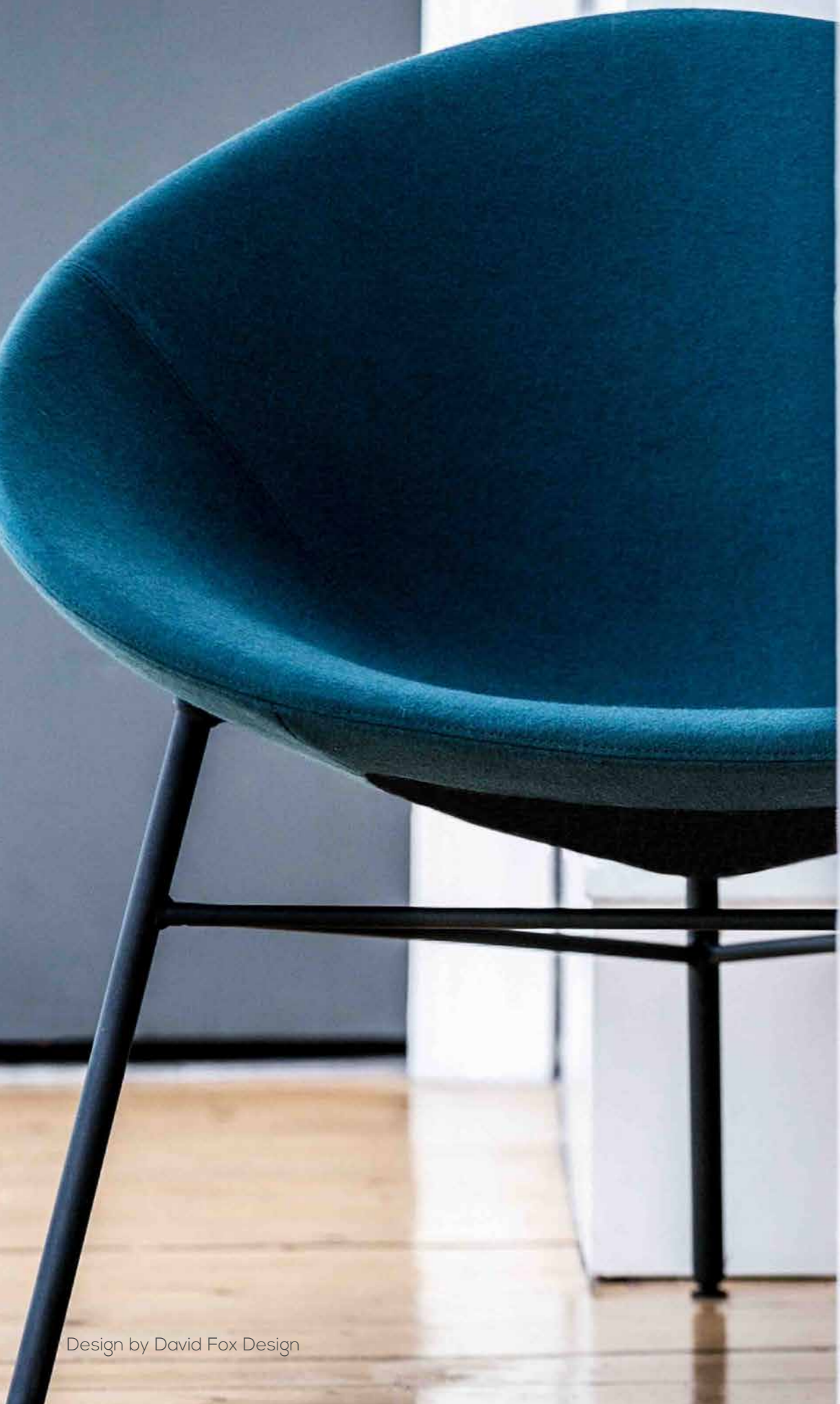

Design by David Fox Design

Pear

Product Code: SPR1

Description: Lounge chair with a chrome effect or matt black 3 leg metal frame

Price	£	€	\$	Price	£	€	\$
Group 3	£647	€716	\$872	Group 6	£894	€989	\$1,205
Group 4	£688	€761	\$927	Group 7	£997	€1,103	\$1,343
Group 5	£740	€819	\$997				

Dimensions

Height	830mm
Width	875mm
Depth	610mm
Seat Height	420mm
Weight	14kg



Product Code: SPR2

Description: Compact armchair with a chrome effect or matt black 4 leg metal frame

Price	£	€	\$	Price	£	€	\$
Group 3	£477	€528	\$642	Group 6	£671	€742	\$904
Group 4	£510	€565	\$687	Group 7	£751	€831	\$1,011
Group 5	£550	€609	\$741				

Dimensions

Height	840mm
Width	600mm
Depth	600mm
Seat Height	440mm
Weight	13kg



Product Code: SPR3

Description: Lounge chair with 4 leg oak frame. Black and Wenge stained options also available

Price	£	€	\$	Price	£	€	\$
Group 3	£895	€1,030	\$1,254	Group 6	£1,142	€1,314	\$1,600
Group 4	£936	€1,077	\$1,311	Group 7	£1,245	€1,433	\$1,744
Group 5	£988	€1,137	\$1,384	Black Stained Oak	+£130	+€145	+\$176
				Wenge Stained Oak	+£130	+€145	+\$176

Dimensions

Height	830mm
Width	880mm
Depth	760mm
Seat Height	420mm
Weight	14kg



Metal



Standard
FOC

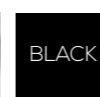

Special
FOC

Wood



Standard
FOC



Special

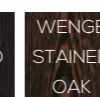

Special

Fabrics



See pg 233

Rollie



Product Code: SRLI/D
Description: Armchair with chrome effect or black 4 star fixed metal base

Price	£	€	\$	Price	£	€	\$	Dimensions
Group 0	£586	€649	\$789	Group 6	£902	€998	\$1,215	Height 780mm
Group 1	£607	€672	\$817	Group 7	£973	€1,077	\$1,310	Width 642mm
Group 2	£637	€705	\$859	Leather 1	£830	€918	\$1,118	Depth 665mm
Group 3	£667	€739	\$899	Leather 2	£956	€1,058	\$1,288	Seat Height 460mm
Group 4	£688	€762	\$927	Leather 3	£1,082	€1,197	\$1,457	Weight 9kg
Group 5	£729	€807	\$982					



Product Code: SRLI/E
Description: Armchair with chrome effect or black 4 star swivel metal base

Price	£	€	\$	Price	£	€	\$	Dimensions
Group 0	£649	€718	\$874	Group 6	£964	€1,066	\$1,298	Height 780mm
Group 1	£669	€740	\$901	Group 7	£1,035	€1,145	\$1,394	Width 642mm
Group 2	£699	€773	\$941	Leather 1	£892	€987	\$1,202	Depth 665mm
Group 3	£730	€808	\$984	Leather 2	£1,018	€1,126	\$1,371	Seat Height 460mm
Group 4	£750	€831	\$1,011	Leather 3	£1,145	€1,267	\$1,542	Weight 10kg
Group 5	£790	€874	\$1,065					



Product Code: SRLI/C
Description: Armchair with chrome effect or black 4 leg metal base

Price	£	€	\$	Price	£	€	\$	Dimensions
Group 0	£548	€607	\$738	Group 6	£864	€957	\$1,164	Height 780mm
Group 1	£568	€629	\$765	Group 7	£934	€1,034	\$1,258	Width 642mm
Group 2	£598	€663	\$807	Leather 1	£792	€877	\$1,067	Depth 665mm
Group 3	£630	€698	\$848	Leather 2	£918	€1,016	\$1,236	Seat Height 460mm
Group 4	£650	€719	\$875	Leather 3	£1,044	€1,155	\$1,407	Weight 9kg
Group 5	£690	€765	\$930					

Matching Tables:
 Gloss [pg 143](#)

Metal



Standard FOC Special FOC

Fabrics



See pg 233

Rollie



Product Code: SRLI/S/B
Description: Armchair with black or chrome metal base and casters

Price	£	€	\$	Price	£	€	\$	Dimensions
Group 0	£719	€799	\$971	Group 6	£1,040	€1,155	\$1,404	Height 780mm
Group 1	£740	€822	\$999	Group 7	£1,195	€1,327	\$1,614	Width 642mm
Group 2	£770	€855	\$1,040	Leather 1	£954	€1,059	\$1,288	Depth 665mm
Group 3	£810	€900	\$1,094	Leather 2	£1,080	€1,199	\$1,458	Seat Height 460mm
Group 4	£831	€923	\$1,122	Leather 3	£1,206	€1,339	\$1,629	Weight 11kg
Group 5	£872	€968	\$1,178					



Product Code: SRLI/A
Description: Armchair with solid oak 4 leg broomstick fixed base. Black and Wenge stained options also available

Price	£	€	\$	Price	£	€	\$	Dimensions
Group 0	£683	€757	\$920	Group 6	£998	€1,105	\$1,344	Height 780mm
Group 1	£703	€778	\$947	Group 7	£1,069	€1,184	\$1,440	Width 642mm
Group 2	£733	€812	\$988	Leather 1	£927	€1,026	\$1,249	Depth 665mm
Group 3	£764	€845	\$1,029	Leather 2	£1,053	€1,165	\$1,418	Seat Height 460mm
Group 4	£784	€867	\$1,056	Leather 3	£1,178	€1,304	\$1,587	Weight 10kg
Group 5	£824	€912	\$1,111	Black Stained Oak	+£130	+€145	+\$176	
				Wenge Stained Oak	+£130	+€145	+\$176	



Product Code: SRLI/B
Description: Armchair with solid oak 4 leg broomstick swivel base. Black and Wenge stained options also available

Price	£	€	\$	Price	£	€	\$	Dimensions
Group 0	£775	€858	\$1,045	Group 6	£1,091	€1,207	\$1,469	Height 780mm
Group 1	£796	€881	\$1,073	Group 7	£1,162	€1,286	\$1,566	Width 642mm
Group 2	£825	€913	\$1,112	Leather 1	£1,019	€1,127	\$1,373	Depth 665mm
Group 3	£857	€948	\$1,154	Leather 2	£1,145	€1,266	\$1,541	Seat Height 460mm
Group 4	£877	€971	\$1,181	Leather 3	£1,271	€1,406	\$1,712	Weight 11kg
Group 5	£918	€1,016	\$1,236	Black Stained Oak	+£130	+€145	+\$176	
				Wenge Stained Oak	+£130	+€145	+\$176	

Matching Table:
 Omni [pg 142](#)

Wood



Standard FOC Special Special

Fabrics



See pg 233

Korus

Armchair with solid oak 4 leg base



Korus

Product Code: SKOIE/C
Description: Armchair with chrome effect or black 4 leg metal base
Certification: BS EN 1573: 2007

Price	£	€	\$	Price	£	€	\$	Dimensions	
Group 0	£605	€670	\$815	Group 6	£905	€1,002	\$1,220	Height	840mm
Group 1	£625	€692	\$842	Group 7	£973	€1,077	\$1,311	Width	634mm
Group 2	£653	€723	\$880	Leather 1	£838	€927	\$1,129	Depth	661mm
Group 3	£682	€755	\$919	Leather 2	£957	€1,059	\$1,289	Seat Height	460mm
Group 4	£702	€777	\$945	Leather 3	£1,077	€1,191	\$1,450	Weight	11kg
Group 5	£741	€820	\$997						



Product Code: SKOIH/C
Description: Armchair with chrome effect or black metal wire base

Price	£	€	\$	Price	£	€	\$	Dimensions	
Group 0	£660	€731	\$889	Group 6	£961	€1,063	\$1,295	Height	840mm
Group 1	£679	€752	\$915	Group 7	£1,029	€1,138	\$1,386	Width	634mm
Group 2	£708	€784	\$954	Leather 1	£893	€988	\$1,203	Depth	640mm
Group 3	£737	€817	\$993	Leather 2	£1,013	€1,121	\$1,364	Seat Height	460mm
Group 4	£757	€839	\$1,020	Leather 3	£1,133	€1,253	\$1,526	Weight	12kg
Group 5	£797	€882	\$1,074						



Product Code: SKOIK/C
Description: Armchair with chrome effect or black metal 4 star fixed base

Price	£	€	\$	Price	£	€	\$	Dimensions	
Group 0	£707	€783	\$953	Group 6	£1,009	€1,117	\$1,359	Height	864mm
Group 1	£727	€805	\$980	Group 7	£1,076	€1,191	\$1,450	Width	634mm
Group 2	£756	€837	\$1,019	Leather 1	£941	€1,041	\$1,267	Depth	634mm
Group 3	£784	€868	\$1,057	Leather 2	£1,061	€1,174	\$1,429	Seat Height	460mm
Group 4	£804	€890	\$1,084	Leather 3	£1,181	€1,306	\$1,590	Weight	12kg
Group 5	£843	€933	\$1,136	4 star swivel base	+£50	+€56	+\$68		



Product Code: SKOIO/O
Description: Armchair with solid oak 4 leg base. Black and Wenge stained options also available
Certification: BS EN 16139: 2013

Price	£	€	\$	Price	£	€	\$	Dimensions	
Group 0	£771	€853	\$1,039	Group 6	£1,071	€1,186	\$1,443	Height	840mm
Group 1	£790	€874	\$1,064	Group 7	£1,139	€1,260	\$1,534	Width	634mm
Group 2	£819	€906	\$1,103	Leather 1	£1,003	€1,110	\$1,351	Depth	661mm
Group 3	£848	€939	\$1,143	Leather 2	£1,123	€1,244	\$1,513	Seat Height	460mm
Group 4	£867	€960	\$1,168	Leather 3	£1,243	€1,376	\$1,674	Weight	15kg
Group 5	£905	€1,002	\$1,220	Black Stained Oak	+£130	+€145	+\$176		
				Wenge Stained Oak	+£130	+€145	+\$176		



Matching Table:
 Gloss pg 143

Metal

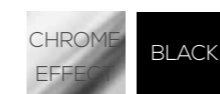

Standard FOC Special FOC

Wood

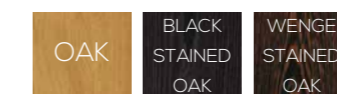

Standard FOC Special Special

Fabrics



See pg 233

Korus Quilted

Quilted armchair with broomstick base

Statement Chairs

Korus quilted

Product Code: SKO2/PO/O

Description: Armchair with quilted upholstery detail and solid oak 4 leg broomstick fixed base. Black and Wenge stained options also available

Price	£	€	\$	Price	£	€	\$	Dimensions	
Group 0	£997	€1,104	\$1,343	Group 6	£1,382	€1,530	\$1,862	Height	860mm
Group 1	£1,022	€1,131	\$1,377	Group 7	£1,469	€1,625	\$1,978	Width	634mm
Group 2	£1,053	€1,165	\$1,418	Leather 1	£1,295	€1,432	\$1,744	Depth	460mm
Group 3	£1,096	€1,213	\$1,477	Leather 2	£1,448	€1,602	\$1,950	Seat Height	456mm
Group 4	£1,120	€1,240	\$1,509	Leather 3	£1,602	€1,773	\$2,158	Weight	13kg
Group 5	£1,170	€1,295	\$1,576	Black Stained Oak	+£130	+€145	+\$176		
				Wenge Stained Oak	+£130	+€145	+\$176		



Product Code: SKO2/PO/O

Description: Armchair with quilted upholstery detail and solid oak 4 leg broomstick swivel base. Black and Wenge stained options also available

Price	£	€	\$	Price	£	€	\$	Dimensions	
Group 0	£1,120	€1,240	\$1,509	Group 6	£1,505	€1,665	\$2,027	Height	860mm
Group 1	£1,145	€1,267	\$1,543	Group 7	£1,593	€1,762	\$2,145	Width	634mm
Group 2	£1,177	€1,302	\$1,585	Leather 1	£1,419	€1,569	\$1,911	Depth	460mm
Group 3	£1,220	€1,351	\$1,644	Leather 2	£1,573	€1,740	\$2,119	Seat Height	456mm
Group 4	£1,245	€1,379	\$1,677	Leather 3	£1,726	€1,910	\$2,325	Weight	14kg
Group 5	£1,295	€1,432	\$1,744	Black Stained Oak	+£130	+€145	+\$176		
				Wenge Stained Oak	+£130	+€145	+\$176		



Product Code: SKO2/KL/O

Description: Armchair with quilted upholstery detail and chrome effect or black metal 4 star fixed base

Price	£	€	\$	Price	£	€	\$	Dimensions	
Group 0	£937	€1,037	\$1,262	Group 6	£1,322	€1,462	\$1,780	Height	864mm
Group 1	£961	€1,063	\$1,295	Group 7	£1,409	€1,559	\$1,898	Width	634mm
Group 2	£993	€1,099	\$1,338	Leather 1	£1,235	€1,367	\$1,664	Depth	460mm
Group 3	£1,036	€1,146	\$1,395	Leather 2	£1,388	€1,536	\$1,869	Seat Height	460mm
Group 4	£1,061	€1,174	\$1,429	Leather 3	£1,542	€1,706	\$2,076	Weight	12kg
Group 5	£1,111	€1,230	\$1,497						



Product Code: SKO2/KL/O

Description: Armchair with quilted upholstery detail and chrome effect or black metal 4 star swivel base

Price	£	€	\$	Price	£	€	\$	Dimensions	
Group 0	£1,019	€1,127	\$1,373	Group 6	£1,404	€1,553	\$1,891	Height	864mm
Group 1	£1,044	€1,155	\$1,406	Group 7	£1,491	€1,650	\$2,008	Width	634mm
Group 2	£1,075	€1,190	\$1,449	Leather 1	£1,317	€1,458	\$1,774	Depth	460mm
Group 3	£1,118	€1,238	\$1,506	Leather 2	£1,471	€1,627	\$1,980	Seat Height	460mm
Group 4	£1,143	€1,265	\$1,540	Leather 3	£1,623	€1,796	\$2,186	Weight	13kg
Group 5	£1,193	€1,320	\$1,608						



Matching Table:

Gloss	pg 143
Omni	pg 142

Metal

CHROME EFFECT	BLACK
Standard FOC	Special

Wood

OAK	BLACK STAINED OAK	WENGE STAINED OAK
Standard FOC	Special	Special

Fabrics



See pg 233

Swoosh Metal



Product Code: MSS1A
Description: Meeting chair with chrome effect, black or white metal wire base. Stacks to 5 high
Certification: BS EN 16139: 2013 Level 1

Price	£	€	\$	Price	£	€	\$	Dimensions
Group 0	£451	€500	\$608	Group 6	£842	€932	\$1,134	Height 835mm
Group 1	£468	€518	\$630	Group 7	£911	€1,008	\$1,227	Width 500mm
Group 2	£488	€540	\$657	Leather 1	£683	€756	\$920	Depth 630mm
Group 3	£517	€572	\$696	Leather 2	£803	€888	\$1,081	Seat Height 455mm
Group 4	£532	€589	\$717	Leather 3	£921	€1,019	\$1,241	Weight 11kg
Group 5	£678	€750	\$913					



Product Code: SSW1A
Description: Lounge chair with chrome effect, black or white metal wire base
Certification: BS EN 16139: 2013 Level 1

Price	£	€	\$	Price	£	€	\$	Dimensions
Group 0	£503	€557	\$678	Group 6	£958	€1,060	\$1,290	Height 795mm
Group 1	£522	€578	\$703	Group 7	£1,038	€1,148	\$1,398	Width 640mm
Group 2	£546	€604	\$735	Leather 1	£776	€858	\$1,045	Depth 690mm
Group 3	£579	€641	\$780	Leather 2	£916	€1,014	\$1,234	Seat Height 420mm
Group 4	£598	€662	\$805	Leather 3	£1,057	€1,169	\$1,423	Weight 13kg
Group 5	£765	€847	\$1,031					



Product Code: SSW1B
Description: Lounge chair with chrome effect, black or white metal 4 star swivel base
Certification: BS EN 16139: 2013 Level 1

Price	£	€	\$	Price	£	€	\$	Dimensions
Group 0	£518	€573	\$698	Group 6	£842	€932	\$1,134	Height 795mm
Group 1	£530	€587	\$714	Group 7	£893	€988	\$1,203	Width 640mm
Group 2	£545	€603	\$734	Leather 1	£688	€762	\$927	Depth 690mm
Group 3	£565	€625	\$761	Leather 2	£776	€858	\$1,045	Seat Height 420mm
Group 4	£577	€639	\$777	Leather 3	£864	€956	\$1,164	Weight 19kg
Group 5	£723	€800	\$973					



Product Code: TROLLEYSWOOSH
Description: Trolley enabling stacking of applicable Swoosh chairs up to 5 high. Available in black only

Price	£	€	\$
	£595	€685	\$833

Matching Tables:
 Gloss [pg 143](#)

Metal

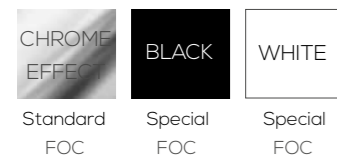

Fabrics



See pg 233

Swoosh Wooden



Product Code: MSW1E
Description: Meeting chair with solid oak 4 leg base. Black and Wenge stained options also available

Price	£	€	\$	Price	£	€	\$	Dimensions
Group 0	£608	€673	\$819	Group 6	£874	€966	\$1,176	Height 835mm
Group 1	£625	€692	\$842	Group 7	£935	€1,034	\$1,259	Width 500mm
Group 2	£646	€715	\$870	Leather 1	£835	€924	\$1,125	Depth 630mm
Group 3	£677	€749	\$912	Leather 2	£952	€1,053	\$1,281	Seat Height 455mm
Group 4	£694	€768	\$934	Leather 3	£1,069	€1,183	\$1,440	
Group 5	£728	€805	\$980	Black Stained Oak	+£130	+€145	+\$176	
				Wenge Stained Oak	+£130	+€145	+\$176	

Product Code: SSW1E
Description: Lounge chair with solid oak 4 leg base. Black and Wenge stained options also available

Price	£	€	\$	Price	£	€	\$	Dimensions
Group 0	£674	€746	\$908	Group 6	£988	€1,093	\$1,330	Height 795mm
Group 1	£694	€768	\$934	Group 7	£1,059	€1,171	\$1,426	Width 640mm
Group 2	£720	€796	\$969	Leather 1	£941	€1,041	\$1,267	Depth 690mm
Group 3	£755	€835	\$1,017	Leather 2	£1,077	€1,192	\$1,451	Seat Height 420mm
Group 4	£775	€857	\$1,043	Leather 3	£1,216	€1,345	\$1,637	
Group 5	£815	€902	\$1,098	Black Stained Oak	+£130	+€145	+\$176	
				Wenge Stained Oak	+£130	+€145	+\$176	



Product Code: MSW1F
Description: Meeting chair with arms & solid oak 4 leg base. Black and Wenge stained options also available

Price	£	€	\$	Price	£	€	\$	Dimensions
Group 0	£727	€804	\$979	Group 6	£994	€1,100	\$1,339	Height 835mm
Group 1	£745	€824	\$1,003	Group 7	£1,055	€1,167	\$1,420	Width 562mm
Group 2	£766	€848	\$1,032	Leather 1	£954	€1,055	\$1,284	Depth 630mm
Group 3	£797	€881	\$1,073	Leather 2	£1,071	€1,185	\$1,442	Seat Height 455mm
Group 4	£814	€901	\$1,097	Leather 3	£1,188	€1,314	\$1,599	
Group 5	£849	€939	\$1,143	Black Stained Oak	+£130	+€145	+\$176	
				Wenge Stained Oak	+£130	+€145	+\$176	



Product Code: SSW1F
Description: Lounge chair with arms & solid oak 4 leg base. Black and Wenge stained options also available

Price	£	€	\$	Price	£	€	\$	Dimensions
Group 0	£788	€872	\$1,062	Group 6	£1,102	€1,219	\$1,484	Height 795mm
Group 1	£808	€894	\$1,088	Group 7	£1,173	€1,298	\$1,580	Width 702mm
Group 2	£834	€923	\$1,123	Leather 1	£1,056	€1,168	\$1,421	Depth 690mm
Group 3	£869	€962	\$1,171	Leather 2	£1,194	€1,321	\$1,608	Seat Height 420mm
Group 4	£889	€984	\$1,197	Leather 3	£1,330	€1,471	\$1,791	
Group 5	£931	€1,030	\$1,253	Black Stained Oak	+£130	+€145	+\$176	
				Wenge Stained Oak	+£130	+€145	+\$176	



Wood

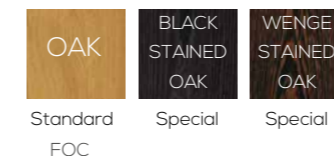

Fabrics



See pg 233

Check

Armchair with wooden base & button detail



Design by High Design



Metal Base



Wooden Base



Pleated Upholstery Detail



With or Without Buttons

Check Metal

Product Code: SCK1/A

Description: Armchair with pleated upholstery detail and chrome effect 4 leg base. Available with or without buttons



Price	£	€	\$	Price	£	€	\$	Dimensions
Group 0	£1,437	€1,590	\$1,935	Group 6	£2,131	€2,357	\$2,869	Height 758mm
Group 1	£1,481	€1,638	\$1,994	Group 7	£2,494	€2,758	\$3,358	Width 940mm
Group 2	£1,548	€1,712	\$2,084	Leather 1	£2,069	€2,288	\$2,785	Depth 900mm
Group 3	£1,657	€1,832	\$2,231	Leather 2	£2,757	€3,049	\$3,712	Seat Height 420mm
Group 4	£1,723	€1,906	\$2,320	With Buttons (B/B)	+£50	+€55	+\$67	Weight 30kg
Group 5	£1,832	€2,027	\$2,467					

Product Code: SCK2/A

Description: 2 seat sofa with pleated upholstery detail and chrome effect 4 leg base. Available with or without buttons



Price	£	€	\$	Price	£	€	\$	Dimensions
Group 0	£1,930	€2,135	\$2,599	Group 6	£2,917	€3,226	\$3,927	Height 758mm
Group 1	£1,993	€2,204	\$2,683	Group 7	£3,435	€3,799	\$4,625	Width 1,620mm
Group 2	£2,087	€2,309	\$2,810	Leather 1	£2,764	€3,057	\$3,722	Depth 900mm
Group 3	£2,243	€2,481	\$3,020	Leather 2	£3,686	€4,076	\$4,962	Seat Height 420mm
Group 4	£2,337	€2,585	\$3,146	With Buttons (B/B)	+£100	+€110	+\$134	Weight 55kg
Group 5	£2,495	€2,759	\$3,359					

Product Code: SCK3/A

Description: 3 seat sofa with pleated upholstery detail and chrome effect 4 leg base. Available with or without buttons



Price	£	€	\$	Price	£	€	\$	Dimensions
Group 0	£2,559	€2,831	\$3,446	Group 6	£3,811	€4,214	\$5,130	Height 758mm
Group 1	£2,638	€2,918	\$3,552	Group 7	£4,467	€4,940	\$6,013	Width 2,300mm
Group 2	£2,760	€3,053	\$3,716	Leather 1	£3,466	€3,833	\$4,667	Depth 900mm
Group 3	£2,956	€3,269	\$3,979	Leather 2	£4,711	€5,210	\$6,342	Seat Height 420mm
Group 4	£3,074	€3,400	\$4,139	With Buttons (B/B)	+£150	+€167	+\$203	Weight 68kg
Group 5	£3,320	€3,671	\$4,469					

Matching Table:

Check [pg 146](#)

Metal

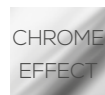

Standard FOC

Fabrics



See pg 233

Check Wooden

Product Code: SCK1/B

Description: Armchair with pleated upholstery detail and solid oak 4 leg base. Black and Wenge stained options also available. Available with or without buttons



Price	£	€	\$	Price	£	€	\$	Dimensions
Group 0	£1,798	€1,996	\$2,428	Group 6	£2,651	€2,943	\$3,579	Height 758mm
Group 1	£1,851	€2,055	\$2,499	Group 7	£3,057	€3,394	\$4,127	Width 940mm
Group 2	£1,933	€2,146	\$2,610	Leather 1	£2,550	€2,831	\$3,443	Depth 900mm
Group 3	£2,068	€2,296	\$2,792	Leather 2	£3,111	€3,454	\$4,200	Seat Height 420mm
Group 4	£2,159	€2,397	\$2,915	Black Stained Oak	+£150	+€167	+\$203	Weight 32kg
Group 5	£2,495	€2,770	\$3,369	Wenge Stained Oak	+£150	+€167	+\$203	
				With Buttons (B/B)	+£50	+€55	+\$67	

Product Code: SCK2/B

Description: 2 seat sofa with pleated upholstery detail and solid oak 4 leg base. Black and Wenge stained options also available. Available with or without buttons



Price	£	€	\$	Price	£	€	\$	Dimensions
Group 0	£2,377	€2,639	\$3,209	Group 6	£3,589	€3,984	\$4,846	Height 758mm
Group 1	£2,447	€2,717	\$3,304	Group 7	£4,166	€4,625	\$5,625	Width 1,620mm
Group 2	£2,563	€2,845	\$3,461	Leather 1	£3,367	€3,738	\$4,546	Depth 900mm
Group 3	£2,756	€3,060	\$3,721	Leather 2	£4,379	€4,861	\$5,912	Seat Height 420mm
Group 4	£2,878	€3,195	\$3,886	Black Stained Oak	+£175	+€195	+\$237	Weight 57kg
Group 5	£3,064	€3,402	\$4,137	Wenge Stained Oak	+£175	+€195	+\$237	
				With Buttons (B/B)	+£100	+€110	+\$134	

Product Code: SCK3/B

Description: 3 seat sofa with pleated upholstery detail and solid oak 4 leg base. Black and Wenge stained options also available. Available with or without buttons.



Price	£	€	\$	Price	£	€	\$	Dimensions
Group 0	£2,932	€3,255	\$3,959	Group 6	£4,482	€4,976	\$6,051	Height 758mm
Group 1	£3,036	€3,370	\$4,099	Group 7	£5,215	€5,789	\$7,041	Width 2,300mm
Group 2	£3,182	€3,533	\$4,296	Leather 1	£4,156	€4,614	\$5,611	Depth 900mm
Group 3	£3,422	€3,799	\$4,620	Leather 2	£5,523	€6,131	\$7,457	Seat Height 420mm
Group 4	£3,579	€3,973	\$4,832	Black Stained Oak	+£200	+€222	+\$270	Weight 71kg
Group 5	£3,867	€4,293	\$5,221	Wenge Stained Oak	+£200	+€222	+\$270	
				With Buttons (B/B)	+£150	+€167	+\$203	

Matching Table:

Check [pg 146](#)

Wood



Standard FOC Special Special

Special Details

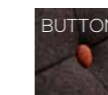

Special

Fabrics



See pg 233

Leo

3 seat sofa with metal base & Leo coffee table



Design by km34

Leo

Product Code: SLE1

Description: Armchair with sprung seat and matt black or chrome effect 4 leg metal base

Certification: BS EN 16139:2013 Level 1

Price	£	€	\$	Dimensions	
Group 3	£1,813	€2,005	\$2,441	Height	730mm
Group 4	£1,953	€2,160	\$2,630	Width	950mm
Group 5	£2,022	€2,236	\$2,722	Depth	820mm
Group 6	£2,440	€2,698	\$3,285	Seat Height	420mm
Group 7	£2,947	€3,260	\$3,968	Weight	34kg



Product Code: SLE2

Description: 2 seat sofa with sprung seat and matt black or chrome effect 4 leg metal base

Certification: BS EN 16139:2013 Level 1

Price	£	€	\$	Dimensions	
Group 3	£2,660	€2,942	\$3,582	Height	730mm
Group 4	£2,791	€3,087	\$3,758	Width	1,760mm
Group 5	£2,900	€3,207	\$3,904	Depth	820mm
Group 6	£3,435	€3,799	\$4,625	Seat Height	420mm
Group 7	£4,058	€4,488	\$5,463	Weight	61kg



Product Code: SLE3

Description: 3 seat sofa with sprung seat and matt black or chrome effect 4 leg metal base

Certification: BS EN 16139:2013 Level 1

Price	£	€	\$	Dimensions	
Group 3	£3,403	€3,763	\$4,581	Height	730mm
Group 4	£3,551	€3,927	\$4,780	Width	2,570mm
Group 5	£3,674	€4,063	\$4,947	Depth	820mm
Group 6	£4,278	€4,730	\$5,759	Seat Height	420mm
Group 7	£4,987	€5,515	\$6,713	Weight	89kg



Matching Table:

Leo [pg 146](#)

Leg



Standard
FOC

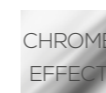

Special
FOC

Fabrics



See pg 233

Mortimer

Armchair with solid oak leg base



Design by Jones & Partners

Sofas & Armchairs

Mortimer

Product Code: SMO1/1

Description: Armchair with solid oak 4 leg base. Black and Wenge stained options also available

Certification: BS EN 15373:2007. BS EN 1022:2005

Price	£	€	\$	Price	£	€	\$	Dimensions
Group 3	£860	€952	\$1,158	Leather 1	£1,051	€1,163	\$1,416	Height 845mm
Group 4	£884	€978	\$1,190	Leather 2	£1,199	€1,326	\$1,615	Width 680mm
Group 5	£932	€1,031	\$1,255	Leather 3	£1,347	€1,490	\$1,813	Depth 700mm
Group 6	£1,135	€1,255	\$1,528	Black Stained Oak	+£130	+€145	+\$176	Seat Height 460mm
Group 7	£1,219	€1,348	\$1,641	Wenge Stained Oak	+£130	+€145	+\$176	Weight 14kg



Product Code: SMO2/1

Description: Three seat sofa with solid oak 4 leg base. Black and Wenge stained options also available

Price	£	€	\$	Dimensions
Group 3	£2,091	€2,313	\$2,816	Height 920mm
Group 4	£2,204	€2,437	\$2,967	Width 2,020mm
Group 5	£2,401	€2,656	\$3,233	Depth 875mm
Group 6	£3,108	€3,437	\$4,184	Seat Height 450mm
Group 7	£3,860	€4,269	\$5,197	Weight 72kg
Black Stained Oak	+£130	+€145	+\$176	
Wenge Stained Oak	+£130	+€145	+\$176	



Matching Tables:

Mortimer [pg 146](#)

Wood

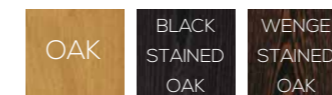

Standard FOC Special Special

Fabrics



See pg 233

Tryst
Sofas & Armchairs



Integrated Work Surface

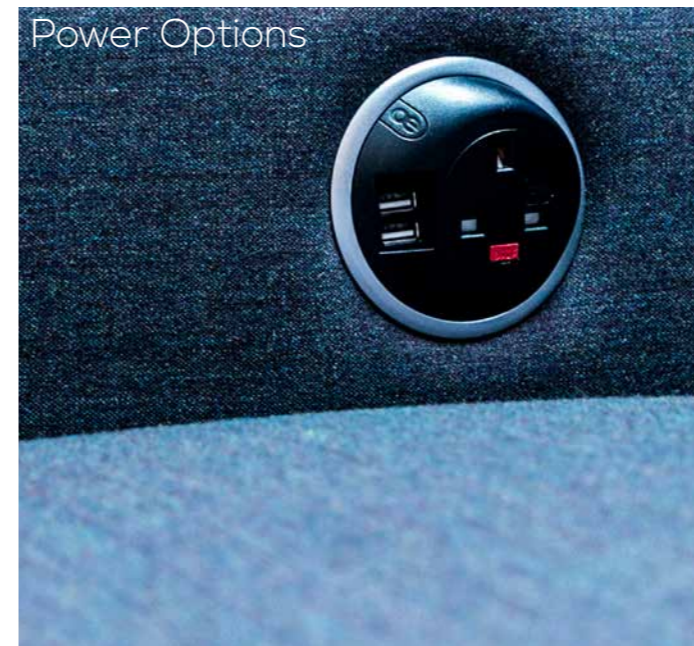

Power Options



Black & Polished
Aluminium Legs



Sprung Seats

Tryst Armchair & Sofas



Product Code: STK1
Description: Low back armchair with black metal, polished aluminium or solid oak legs (upgrade cost applies)

Price	£	€	\$	Dimensions
Group 3	£1,878	€2,077	\$2,529	Height 763mm
Group 4	£1,954	€2,161	\$2,631	Width 980mm
Group 5	£2,011	€2,225	\$2,708	Depth 810mm
Group 6	£2,320	€2,566	\$3,124	Seat Height 480mm
				Weight 63kg



Product Code: STK3
Description: Low back 2 seat sofa with black metal, polished aluminium or solid oak legs (upgrade cost applies)

Price	£	€	\$	Dimensions
Group 3	£2,636	€2,916	\$3,549	Height 763mm
Group 4	£2,768	€3,062	\$3,727	Width 1,620mm
Group 5	£3,083	€3,409	\$4,150	Depth 810mm
Group 6	£3,454	€3,820	\$4,650	Seat Height 480mm
				Weight 78kg



Product Code: STK5
Description: Low back 3 seat sofa with black metal, polished aluminium or solid oak legs (upgrade cost applies)

Price	£	€	\$	Dimensions
Group 3	£2,885	€3,191	\$3,884	Height 763mm
Group 4	£3,035	€3,356	\$4,086	Width 2,270mm
Group 5	£3,161	€3,495	\$4,255	Depth 810mm
Group 6	£3,860	€4,269	\$5,197	Seat Height 480mm
				Weight 106kg

Special Options	£	€	\$
Oak legs	+£254	+€281	+\$342

Metal Leg Wood Leg



Power



Fabrics



Tryst High Back Armchair & Sofas



Product Code: STK2
Description: High back armchair with black metal, polished aluminium or solid oak legs (upgrade cost applies)

Price	£	€	\$	Dimensions
Group 3	£2,710	€2,997	\$3,649	Height 1,335mm
Group 4	£2,843	€3,145	\$3,828	Width 980mm
Group 5	£2,944	€3,256	\$3,964	Depth 810mm
Group 6	£3,492	€3,862	\$4,702	Seat Height 480mm
				Weight 70kg



Product Code: STK4
Description: High back 2 seat sofa with black metal, polished aluminium or solid oak legs (upgrade cost applies)

Price	£	€	\$	Dimensions
Group 3	£3,518	€3,891	\$4,737	Height 1,335mm
Group 4	£3,790	€4,191	\$5,102	Width 1,620mm
Group 5	£3,990	€4,413	\$5,372	Depth 810mm
Group 6	£4,922	€5,443	\$6,627	Seat Height 480mm
				Weight 85kg



Product Code: STK6
Description: High back 3 seat sofa with black metal, polished aluminium or solid oak legs (upgrade cost applies)

Price	£	€	\$	Dimensions
Group 3	£4,088	€4,521	\$5,504	Height 1,335mm
Group 4	£4,326	€4,784	\$5,824	Width 2,270mm
Group 5	£4,564	€5,047	\$6,144	Depth 810mm
Group 6	£5,757	€6,367	\$7,751	Seat Height 480mm
				Weight 137kg

Special Options	£	€	\$
Oak legs	+£254	+€281	+\$342

Metal Leg Wood Leg

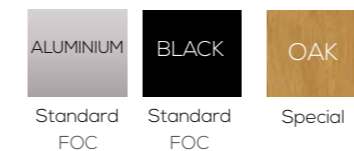

Power



Fabrics



Tryst L-shape Sofas

Tryst Asymmetrical L-shape Sofas



Product Code: STK40
Description: Low back symmetrical L-shape sofa. Available with black metal or polished aluminium legs. Solid oak legs also available (upgrade cost applies)

Price	£	€	\$	Dimensions
Group 3	£6,763	€7,479	\$9,105	Height 763mm
Group 4	£7,113	€7,865	\$9,575	Width 2,447mm
Group 5	£7,933	€8,773	\$10,680	Depth 2,447mm
Group 6	£8,902	€9,844	\$11,984	Seat Height 480mm
				Weight 176kg



Product Code: STK41
Description: Low back symmetrical L-shape sofa with corner table. Available with black metal or polished aluminium legs. Solid oak legs also available (upgrade cost applies)

Price	£	€	\$	Dimensions
Group 3	£7,210	€7,973	\$9,707	Height 763mm
Group 4	£7,485	€8,277	\$10,076	Width 2,447mm
Group 5	£8,205	€9,073	\$11,045	Depth 2,447mm
Group 6	£9,274	€10,255	\$12,484	Seat Height 480mm
				Weight 182kg

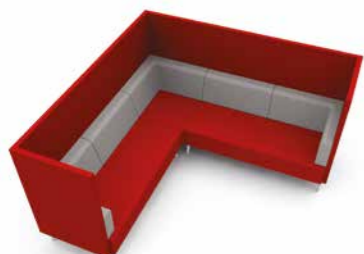

Product Code: STK42
Description: High back symmetrical L-shape sofa. Available with black metal or polished aluminium legs. Solid oak legs also available (upgrade cost applies)

Price	£	€	\$	Dimensions
Group 3	£7,780	€8,636	\$10,503	Height 1,335mm
Group 4	£8,451	€9,381	\$11,409	Width 2,447mm
Group 5	£9,001	€9,992	\$12,152	Depth 2,447mm
Group 6	£10,941	€12,145	\$14,771	Seat Height 480mm
				Weight 218kg

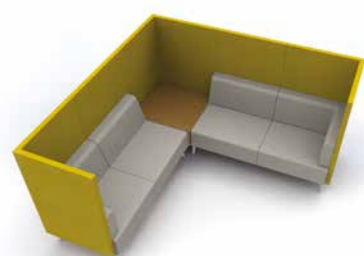

Product Code: STK43
Description: High back symmetrical L-shape sofa with corner table. Available with black metal or polished aluminium legs. Solid oak legs also available (upgrade cost applies)

Price	£	€	\$	Dimensions
Group 3	£8,712	€9,634	\$11,728	Height 1,335mm
Group 4	£9,294	€10,278	\$12,512	Width 2,447mm
Group 5	£9,780	€10,815	\$13,166	Depth 2,447mm
Group 6	£11,982	€13,250	\$16,130	Seat Height 480mm
				Weight 230kg

Special Options	£	€	\$
Oak legs	+£508	+€562	+\$684

Product Code: STK32 (left-handed), STK33 (right-handed, pictured)
Description: Low back asymmetrical L-shape sofa. Available with black metal or polished aluminium legs. Solid oak legs also available (upgrade cost applies)

Price	£	€	\$	Dimensions
Group 3	£5,477	€6,056	\$7,373	Height 763mm
Group 4	£5,753	€6,362	\$7,745	Width 2,447mm
Group 5	£6,276	€6,941	\$8,449	Depth 1,635mm
Group 6	£7,109	€7,862	\$9,571	Seat Height 480mm
				Weight 158kg



Product Code: STK34 (left-handed), STK35 (right-handed, pictured)
Description: Low back asymmetrical L-shape sofa with corner table. Available with black metal or polished aluminium legs. Solid oak legs also available (upgrade cost applies)

Price	£	€	\$	Dimensions
Group 3	£5,914	€6,541	\$7,962	Height 763mm
Group 4	£6,122	€6,771	\$8,242	Width 2,447mm
Group 5	£6,677	€7,383	\$8,988	Depth 1,635mm
Group 6	£7,544	€8,343	\$10,156	Seat Height 480mm
				Weight 162kg



Product Code: STK36 (left-handed), STK37 (right-handed, pictured)
Description: High back asymmetrical L-shape sofa. Available with black metal or polished aluminium legs. Solid oak legs also available (upgrade cost applies)

Price	£	€	\$	Dimensions
Group 3	£7,160	€7,918	\$9,639	Height 1,335mm
Group 4	£7,578	€8,381	\$10,202	Width 2,447mm
Group 5	£8,132	€8,992	\$10,947	Depth 1,635mm
Group 6	£10,050	€11,113	\$13,529	Seat Height 480mm
				Weight 196kg



Product Code: STK38 (left-handed), STK39 (right-handed, pictured)
Description: High back asymmetrical L-shape sofa with corner table. Available with black metal or polished aluminium legs. Solid oak legs also available (upgrade cost applies)

Price	£	€	\$	Dimensions
Group 3	£7,739	€8,558	\$10,418	Height 1,335mm
Group 4	£8,246	€9,119	\$11,101	Width 2,447mm
Group 5	£8,656	€9,572	\$11,653	Depth 1,635mm
Group 6	£10,570	€11,688	\$14,229	Seat Height 480mm
				Weight 206kg

Special Options	£	€	\$
Oak legs	+£508	+€562	+\$684

Metal Leg Wood Leg



Work Surface Power



Fabrics



Metal Leg Wood Leg Work Surface Power



Fabrics



Swoosh Sofas

2 seat sofa with solid oak leg base

Swoosh sofas



Product Code: SSW3A
Description: 2 seat sofa with chrome effect, black or white metal wire base
Certification: BS EN 16139: 2013 Level 1

Price	£	€	\$	Price	£	€	\$	Dimensions	
Group 0	£1,252	€1,385	\$1,686	Group 6	£2,034	€2,250	\$2,739	Height	800mm
Group 1	£1,279	€1,415	\$1,722	Group 7	£2,154	€2,382	\$2,900	Width	1,410mm
Group 2	£1,316	€1,455	\$1,771	Leather 1	£1,661	€1,837	\$2,236	Depth	680mm
Group 3	£1,364	€1,509	\$1,837	Leather 2	£1,870	€2,068	\$2,518	Seat Height	410mm
Group 4	£1,393	€1,540	\$1,875	Leather 3	£2,080	€2,300	\$2,800	Weight	33kg
Group 5	£1,745	€1,930	\$2,350						



Product Code: SSW3C
Description: 2 seat sofa with solid oak 4 leg base. Black and Wenge stained options also available

Price	£	€	\$	Price	£	€	\$	Dimensions	
Group 0	£1,722	€1,905	\$2,319	Group 6	£2,253	€2,491	\$3,033	Height	800mm
Group 1	£1,769	€1,957	\$2,382	Group 7	£2,409	€2,664	\$3,243	Width	1,410mm
Group 2	£1,831	€2,026	\$2,466	Leather 1	£2,152	€2,380	\$2,897	Depth	680mm
Group 3	£1,878	€2,077	\$2,529	Leather 2	£2,372	€2,624	\$3,194	Seat Height	410mm
Group 4	£1,941	€2,146	\$2,613	Leather 3	£2,566	€2,838	\$3,454	Weight	26kg
Group 5	£2,019	€2,233	\$2,718	Black Stained Oak	+£208	+€231	+\$281		
				Wenge Stained Oak	+£208	+€231	+\$281		



Product Code: SSW3D
Description: 2 seat sofa with solid oak arms and 4 leg base. Black and Wenge stained options also available

Price	£	€	\$	Price	£	€	\$	Dimensions	
Group 0	£1,865	€2,062	\$2,511	Group 6	£2,395	€2,649	\$3,225	Height	800mm
Group 1	£1,912	€2,114	\$2,574	Group 7	£2,551	€2,821	\$3,435	Width	1,520mm
Group 2	£1,974	€2,183	\$2,658	Leather 1	£2,294	€2,537	\$3,089	Depth	685mm
Group 3	£2,021	€2,235	\$2,721	Leather 2	£2,515	€2,781	\$3,386	Seat Height	410mm
Group 4	£2,083	€2,304	\$2,805	Leather 3	£2,707	€2,994	\$3,645	Weight	29kg
Group 5	£2,161	€2,390	\$2,910	Black Stained Oak	+£208	+€231	+\$281		
				Wenge Stained Oak	+£208	+€231	+\$281		



Matching Tables:
 Gloss [pg 143](#)

Metal

CHROME EFFECT	BLACK	WHITE
Standard FOC	Special FOC	Special FOC

Wood

OAK	BLACK STAINED OAK	WENGE STAINED OAK
Standard FOC	Special	Special

Fabrics



Horizon

Triform configuration



Horizon Example Configurations

Configuration: Triform

Modules

3 x SHZ10, 3 x SHZ5, 3 x SHZ1, 3 x SHZ2

Price	£	€	\$
Group 3	£25,347	€28,035	\$34,125

Dimensions

Height	730mm
Width	5,920mm
Depth	1,900mm



Configuration: Quadrant

Modules

4 x SHZ10, 4 x SHZ11, 4 x SHZ1, 4 x SHZ2

Price	£	€	\$
Group 3	£31,148	€34,452	\$41,936

Dimensions

Height	730mm
Width	6,760mm
Depth	6,760mm

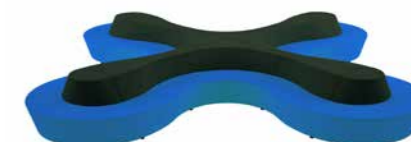

Configuration: Wave

Modules

2 x SHZ11, 2 x SHZ1, 2 x SHZ2

Price	£	€	\$
Group 3	£10,832	€11,982	\$14,584

Dimensions

Height	730mm
Width	4,800mm
Depth	2,400mm



Configuration: Island

Modules

1 x SHZ1, 1 x SHZ2, 1 x SHZ10, 1 x SHZ9

Price	£	€	\$
Group 3	£7,041	€7,788	\$9,480

Dimensions

Height	730mm
Width	2,860mm
Depth	1,900mm



Configuration: L-shape

Modules

1 x SHZ1, 1 x SHZ2, 1 x SHZ11

Price	£	€	\$
Group 3	£5,416	€5,991	\$7,292

Dimensions

Height	730mm
Width	2,400mm
Depth	2,400mm



Configuration: Circle

Modules

2 x SHZ9

Price	£	€	\$
Group 3	£2,560	€2,832	\$3,448

Dimensions

Height	730mm
Width	1,360mm
Depth	1,360mm



Horizon
Triform configuration



Design by Roger Webb Associates

Centro Tables
Solid oak diner table



Design by Roger Webb Associates

Centro Tables

Solid oak diner table



Design by Roger Webb Associates

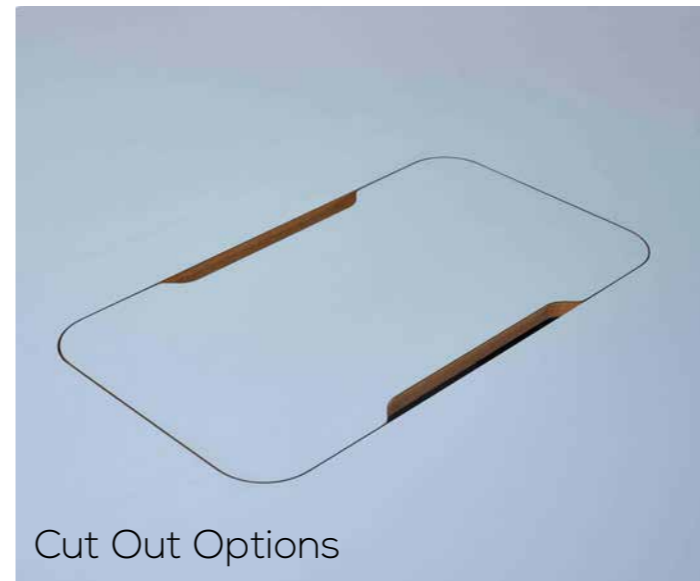

Cut Out Options



Integrated Power Options



Solid Oak Frame & Legs



Fully Integrated Invisible Cable Management Via Leg



Black or Wenge - Stained Oak



Solid Oak Edged Laminated Tops

Centro Solid Oak Statement Tables

Centro Solid Oak Statement Tables (Options)

Egger Standard Laminate

Diner H:750mm	Plain Top (A)			Surface Power (P)			Concealed Power (C)		
	£	€	\$	£	€	\$	£	€	\$
TTRD/200X100	£2,810	€3,108	\$3,783	£3,154	€3,488	\$4,247	£3,383	€3,741	\$4,555
TTRD/260X120	£3,623	€4,007	\$4,878	£4,255	€4,705	\$5,728	£4,484	€4,959	\$6,037
TTRD/320X120	£4,439	€4,909	\$5,976	£5,069	€5,606	\$6,824	£5,298	€5,859	\$7,132
TTRD/360X120	£5,560	€6,394	\$7,784	£5,950	€6,843	\$8,330	£6,430	€7,395	\$9,002
TTRD/400X120	£6,620	€7,320	\$8,911	£6,894	€7,624	\$9,281	£7,583	€8,385	\$10,208

Poseur H:1,060mm	Plain Top (A)			Surface Power (P)			Concealed Power (C)		
	£	€	\$	£	€	\$	£	€	\$
TTRP/200X100	£3,739	€4,135	\$5,033	£4,082	€4,514	\$5,495	£4,312	€4,768	\$5,805
TTRP/260X120	£4,026	€4,452	\$5,420	£4,656	€5,149	\$6,268	£4,885	€5,402	\$6,576
TTRP/320X120	£4,943	€5,466	\$6,655	£5,573	€6,163	\$7,503	£5,722	€6,328	\$7,703
TTRP/360X120	£5,960	€6,854	\$8,344	£6,370	€7,326	\$8,918	£6,744	€7,756	\$9,442
TTRP/400X120	£6,803	€7,523	\$9,158	£7,078	€7,827	\$9,529	£7,766	€8,588	\$10,454



Weight	Width	Depth
48kg	2,000mm	1,000mm
61kg	2,600mm	1,200mm
82kg	3,200mm	1,200mm
94kg	3,600mm	1,200mm
103kg	4,000mm	1,200mm

Weight	Width	Depth
50kg	2,000mm	1,000mm
63kg	2,600mm	1,200mm
84kg	3,200mm	1,200mm
96kg	3,600mm	1,200mm
105kg	4,000mm	1,200mm

Fenix NTM Laminate

Diner H:750mm	Plain Top (A)			Surface Power (P)			Concealed Power (C)		
	£	€	\$	£	€	\$	£	€	\$
TTRD/200X100	£3,210	€3,692	\$4,494	£3,554	€4,087	\$4,976	£3,783	€4,350	\$5,296
TTRD/260X120	£4,023	€4,626	\$5,632	£4,655	€5,353	\$6,517	£4,884	€5,617	\$6,838
TTRD/320X120	£5,239	€6,025	\$7,335	£5,869	€6,749	\$8,217	£6,098	€7,013	\$8,537
TTRD/360X120	£6,360	€7,314	\$8,904	£6,750	€7,763	\$9,450	£7,230	€8,315	\$10,122
TTRD/400X120	£7,420	€8,533	\$10,388	£7,694	€8,848	\$10,772	£8,383	€9,640	\$11,736

Poseur H:1,060mm	Plain Top (A)			Surface Power (P)			Concealed Power (C)		
	£	€	\$	£	€	\$	£	€	\$
TTRP/200X100	£4,139	€4,760	\$5,795	£4,482	€5,154	\$6,275	£4,712	€5,419	\$6,597
TTRP/260X120	£4,426	€5,090	\$6,196	£5,056	€5,814	\$7,078	£5,285	€6,078	\$7,399
TTRP/320X120	£5,743	€6,604	\$8,040	£6,373	€7,329	\$8,922	£6,522	€7,500	\$9,131
TTRP/360X120	£6,760	€7,774	\$9,464	£7,170	€8,246	\$10,038	£7,544	€8,676	\$10,562
TTRP/400X120	£7,603	€8,743	\$10,644	£7,878	€9,060	\$11,029	£8,566	€9,851	\$11,992



Weight	Width	Depth
48kg	2,000mm	1,000mm
61kg	2,600mm	1,200mm
82kg	3,200mm	1,200mm
94kg	3,600mm	1,200mm
103kg	4,000mm	1,200mm

Weight	Width	Depth
50kg	2,000mm	1,000mm
63kg	2,600mm	1,200mm
84kg	3,200mm	1,200mm
96kg	3,600mm	1,200mm
105kg	4,000mm	1,200mm

Power

Power Code	Description	Visual	Surface Power (P)			Concealed Power (C)		
			£	€	\$	£	€	\$
Type A	3 UK fused power sockets		£540	€621	\$756	£157	€181	\$220
Type C	1 dual CAT6 unshielded data socket & 2 UK fused power sockets		£790	€909	\$1,106	£299	€344	\$419
Type D	1 dual USB charger & 2 UK fused power sockets		£760	€874	\$1,064	£241	€278	\$338
Type E	1 dual CAT6 unshielded data, 1 dual USB charger & 1 UK fused power socket		£1,150	€1,323	\$1,610	£405	€466	\$567
Type F	1 HDMI, 1 dual USB charger & 1 UK fused power socket		£1,350	€1,553	\$1,890	£513	€590	\$719

Please note: 2000mm tables come with 1x power cut-out. All other table sizes come with 2x power cut-outs. Each cut-out can accept 1x Surface or 2x Concealed power module/s.

Seating Configuration Example

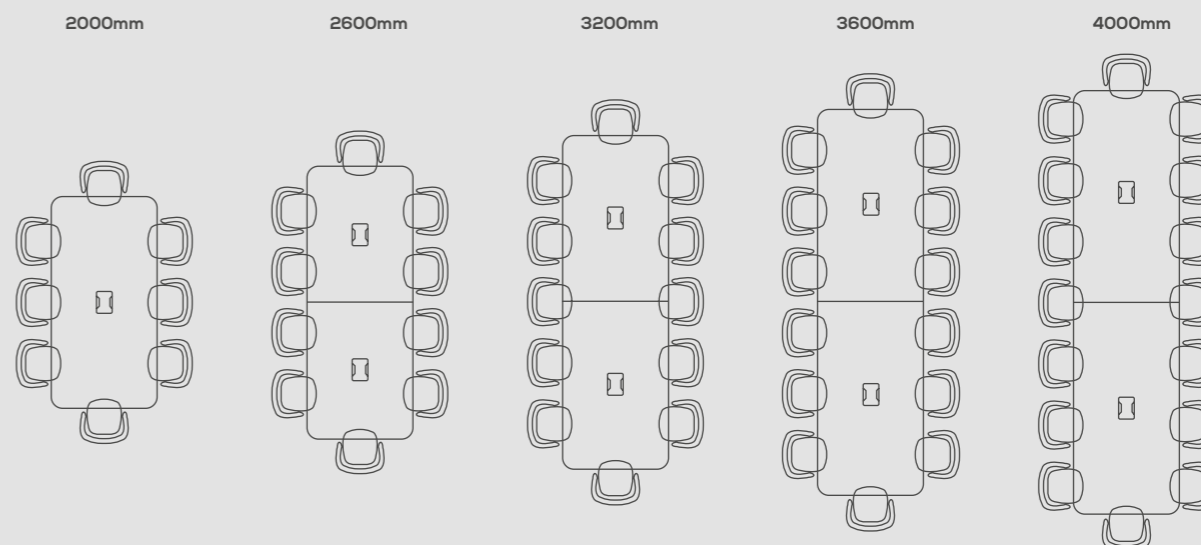

Please note: Diagrams are for illustration purposes only, indicating the approximate seating capacity.

Wood

Standard FOC	Special +£625 +€719 +\$875	Special +£625 +€719 +\$875

Power

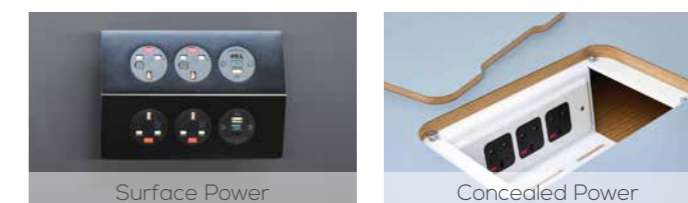

Centro Rustic



Diner - 750mm height

750mm high oak statement table with plywood edged rustic top and legs. Options include an integrated peak power unit and cable management via leg

Plain Top

	£	€	\$
TRUD/200X100	£4,699	€5,404	\$6,579
TRUD/260X120	£5,736	€6,597	\$8,031
TRUD/320X120	£6,238	€7,174	\$8,734
TRUD/360X120	£6,465	€7,435	\$9,051
TRUD/400X120	£6,481	€7,454	\$9,074

Cut Out to accept power

(For Peak Power options please see pg 215)

	£	€	\$	Weight
	£5,009	€5,761	\$7,013	48kg
	£6,046	€6,953	\$8,465	61kg
	£6,548	€7,531	\$9,168	82kg
	£6,775	€7,792	\$9,485	94kg
	£6,791	€7,810	\$9,508	103kg

Poseur - 1,060mm height

1,060mm high oak statement table with plywood edged rustic top and legs. Options include an integrated peak power unit and cable management via leg

Plain Top

	£	€	\$
TRUP/200X100	£5,234	€6,020	\$7,328
TRUP/260X120	£6,386	€7,344	\$8,941
TRUP/320X120	£6,943	€7,985	\$9,721
TRUP/360X120	£7,196	€8,276	\$10,075
TRUP/400X120	£7,213	€8,295	\$10,099

Cut Out to accept power

(For Peak Power options please see pg 215)

	£	€	\$	Weight
	£5,544	€6,376	\$7,762	50kg
	£6,696	€7,701	\$9,375	63kg
	£7,253	€8,341	\$10,155	84kg
	£7,506	€8,632	\$10,509	96kg
	£7,523	€8,652	\$10,533	105kg

Please note: 2000mm tables come with 1x power cut-out. All other table sizes come with 2x power cut-outs. Each cut-out can accept 1x Surface or 2x Concealed power module/s.

Wood



Centro Rustic

Diner table

Fully Integrated Invisible Cable Management via Leg

Peak Power Options

Solid Oak with Plywood Edge Detailing

Centro Lite Café & Meeting Tables

Centro Lite Café & Meeting Tables (Options)

Matching Seating:

- Centro chairs pg166
- Centro stools pg174



Café & Meeting Diner - 750mm height

750mm high oak café & meeting tables with white, grey or oak effect MFMDf top. Black and Wenge stained options also available

Product Code	Power Cutouts	Plain Top (PN)			Surface Power (P)			Pandora Power (D)			Weight
		£	€	\$	£	€	\$	£	€	\$	
TCLD/900RND (3 legs)	0	£1,201	€1,329	\$1,617	n/a	n/a	n/a	n/a	n/a	n/a	28kg
TCLD/1200RND (4 legs)	1	£1,579	€1,746	\$2,126	£1,899	€2,184	\$2,659	£1,899	€2,184	\$2,659	40kg
TCLD/900SQU (4 legs)	1	£1,493	€1,652	\$2,011	£1,813	€2,085	\$2,539	£1,813	€2,085	\$2,539	30kg
TCLD/1200SQU (4 legs)	1	£1,597	€1,767	\$2,151	£1,917	€2,205	\$2,684	£1,917	€2,205	\$2,684	40kg
TCLD/1600X900	1	£1,750	€1,936	\$2,357	£2,070	€2,381	\$2,898	£2,070	€2,381	\$2,898	46kg
TCLD/2000X1000	1	£1,841	€2,036	\$2,478	£2,161	€2,486	\$3,026	£2,161	€2,486	\$3,026	60kg
TCLD/2400X1000	2	£1,926	€2,130	\$2,593	£2,246	€2,583	\$3,145	£2,246	€2,583	\$3,145	70kg
TCLD/3000X1200	2	£2,690	€3,094	\$3,766	£3,010	€3,462	\$4,214	£3,010	€3,462	\$4,214	90kg
TCLD/3600X1200	2	£4,150	€4,773	\$5,810	£4,470	€5,141	\$6,258	£4,470	€5,141	\$6,258	110kg

Café & Meeting Poseur - 1,060mm height

1,060mm high oak café & meeting tables with white, grey or oak effect MFMDf top. Black and Wenge stained options also available

Product Code	Power Cutouts	Plain Top (PN)			Surface Power (P)			Pandora Power (D)			Weight
		£	€	\$	£	€	\$	£	€	\$	
TCLP/900RND (3 legs)	0	£1,364	€1,509	\$1,837	n/a	n/a	n/a	n/a	n/a	n/a	31kg
TCLP/1200RND (4 legs)	1	£1,799	€1,990	\$2,422	£2,119	€2,437	\$2,967	£2,119	€2,437	\$2,967	44kg
TCLP/900SQU (4 legs)	1	£1,708	€1,889	\$2,299	£2,028	€2,333	\$2,840	£2,028	€2,333	\$2,840	34kg
TCLP/1200SQU (4 legs)	1	£1,820	€2,013	\$2,450	£2,140	€2,461	\$2,996	£2,140	€2,461	\$2,996	44kg
TCLP/1600X900	1	£1,984	€2,195	\$2,672	£2,304	€2,650	\$3,226	£2,304	€2,650	\$3,226	50kg
TCLP/2000X1000	1	£2,083	€2,304	\$2,805	£2,403	€2,764	\$3,365	£2,403	€2,764	\$3,365	64kg
TCLP/2400X1000	2	£2,176	€2,406	\$2,929	£2,496	€2,871	\$3,495	£2,496	€2,871	\$3,495	74kg
TCLP/3000X1200	2	£2,940	€3,381	\$4,116	£3,260	€3,749	\$4,564	£3,260	€3,749	\$4,564	90kg
TCLP/3600X1200	2	£4,425	€5,089	\$6,195	£4,745	€5,457	\$6,643	£4,745	€5,457	\$6,643	110kg

Additional Options:	£	€	\$
Black or Wenge Stained Oak	+£495	+€550	+\$669

Please note: All tables include cutouts as shown above and 2x power legs per table.

Power

Power Code	Description	Visual	Surface Power (P)			Pandora Power (D)								
			CTPOWPK/1	CTPOWPK/2		CTPOWPD/1	CTPOWPD/2		£	€	\$			
Type A	3 UK fused power sockets		£540	€621	\$756	£1,050	€1,208	\$1,470	£247	€285	\$346	£474	€546	\$664
Type C	1 dual CAT6 unshielded data socket & 2 UK fused power sockets		£790	€909	\$1,106	£1,550	€1,783	\$2,170	£453	€521	\$635	£886	€1,019	\$1,241
Type D	1 dual USB charger & 2 UK fused power sockets		£760	€874	\$1,064	£1,490	€1,714	\$2,086	£376	€433	\$527	£732	€842	\$1,025
Type E	1 dual CAT6 unshielded data, 1 dual USB charger & 1 UK fused power socket		£1,150	€1,323	\$1,610	£2,270	€2,611	\$3,178	£482	€555	\$675	£944	€1,086	\$1,322
Type F	1 HDMI, 1 dual USB charger & 1 UK fused power socket		£1,350	€1,553	\$1,890	£2,670	€3,071	\$3,738	£761	€876	\$1,066	£1,502	€1,728	\$2,103



Wood

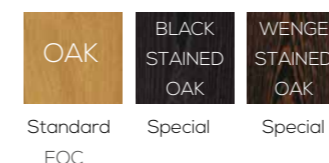

Standard Melamine (MFMDf)



Beam

Poseur height table with clear lacquered frame & natural wood top



Beam

Diner - 750mm height

Product Code: TBMD18X10/, TBMD20X10/, TBMD24X10/

Description: Diner height table with black painted or clear lacquered RSJ frame. Available with a laminate, soft touch or rustic natural or grey stained wood top. Available in 1,800, 2,000 & 2,400 widths.

Prices	Laminate Top			Fenix Top			Rustic Natural Wood Veneered Top		
	£	€	\$	£	€	\$	£	€	\$
Black painted frame									
TBMD18X10/BLK/	£2,859	€3,288	\$4,003	£3,144	€3,616	\$4,402	£3,153	€3,626	\$4,415
TBMD20X10/BLK/	£2,904	€3,340	\$4,066	£3,191	€3,670	\$4,468	£3,200	€3,680	\$4,480
TBMD24X10/BLK/	£2,961	€3,406	\$4,146	£3,252	€3,741	\$4,554	£3,257	€3,746	\$4,560
Clear lacquered frame									
TBMD18X10/CLQ/	£2,859	€3,288	\$4,003	£3,144	€3,616	\$4,402	£3,153	€3,626	\$4,415
TBMD20X10/CLQ/	£2,904	€3,340	\$4,066	£3,191	€3,670	\$4,468	£3,200	€3,680	\$4,480
TBMD24X10/CLQ/	£2,961	€3,406	\$4,146	£3,252	€3,741	\$4,554	£3,257	€3,746	\$4,560

Dimensions : Height 730mm | Width 1,800/2,000/2,400mm | Depth 1,000mm | Weight 124/135/145kg



Poseur - 1,060mm height

Product Code: TBMP20X10/, TBMP24X10/

Description: Poseur height table with black painted or clear lacquered RSJ frame. Available with a laminate, soft touch or rustic natural or grey stained wood top. Available in 2,000 & 2,400mm widths.

Prices	Laminate top			Fenix Top			Rustic Natural Wood Veneered Top		
	£	€	\$	£	€	\$	£	€	\$
Black painted frame									
TBMP20X10/BLK/	£3,120	€3,588	\$4,368	£3,411	€3,923	\$4,776	£3,416	€3,929	\$4,783
TBMP24X10/BLK/	£3,163	€3,638	\$4,429	£3,454	€3,973	\$4,837	£3,459	€3,978	\$4,843
Clear lacquered frame									
TBMP20X10/CLQ/	£3,120	€3,588	\$4,368	£3,411	€3,923	\$4,776	£3,416	€3,929	\$4,783
TBMP24X10/CLQ/	£3,163	€3,638	\$4,429	£3,454	€3,973	\$4,837	£3,459	€3,978	\$4,843

Dimensions : Height 1,060mm | Width 2,000/2,400mm | Depth 1,000mm | Weight 147/157kg



Product Code: TBMP30X10/, TBMP36X10/, TBMP40X10

Description: Large poseur height table with black painted or clear lacquered RSJ frame. Available with a laminate, soft touch or rustic natural or grey stained wood top. Addition of a central leg for core strength. Available in 3,000, 3,600 & 4,000mm widths.

Prices	Laminate Top			Fenix Top			Rustic Natural Wood Veneered Top		
	£	€	\$	£	€	\$	£	€	\$
Black painted frame									
TBMP30X10/BLK/	£4,684	€5,387	\$6,558	£5,070	€5,484	\$6,676	£5,512	€6,339	\$7,717
TBMP36X10/BLK/	£4,949	€5,692	\$6,929	£5,478	€5,885	\$7,164	£5,570	€6,406	\$7,798
TBMP40X10/BLK/	£4,976	€5,723	\$6,967	£5,519	€6,347	\$7,727	£5,611	€6,453	\$7,855
Clear lacquered frame									
TBMP30X10/CLQ/	£4,684	€5,387	\$6,558	£4,768	€5,484	\$6,676	£5,512	€6,339	\$7,717
TBMP36X10/CLQ/	£4,949	€5,692	\$6,929	£5,117	€5,885	\$7,164	£5,570	€6,406	\$7,798
TBMP40X10/CLQ/	£4,976	€5,723	\$6,967	£5,519	€6,347	\$7,727	£5,611	€6,453	\$7,855

Dimensions : Height 1,060mm | Width 3,000/3,600/4,000mm | Depth 1,000mm | Weight 187/215/230kg

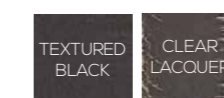

Table Top Finishes



200+ Egger Laminates

Metal Finishes



Beam With Power



Diner - 750mm height, with power

Product Code: TBMD18X10/, TBMD20X10/, TBMD24X10/

Description: Diner height table with black painted or clear lacquered RSJ frame. Available with a laminate, soft touch or rustic natural or grey stained wood top. Plus a choice of Surface (P) or Pandora (D) power. Available in 1,800, 2,000 & 2,400 widths.

Prices	Laminate Top Surface (P) Pandora (D)			Fenix Top Surface (P) Pandora (D)			Rustic Natural Wood Veneered Top Surface (P) Pandora (D)		
	£	€	\$	£	€	\$	£	€	\$
Black painted frame									
TBMD18X10/BLK/	£3,179	€3,656	\$4,450	£3,464	€3,984	\$4,850	£3,473	€3,994	\$4,862
TBMD20X10/BLK/	£3,224	€3,708	\$4,514	£3,511	€4,038	\$4,916	£3,520	€4,049	\$4,929
TBMD24X10/BLK/	£3,281	€3,774	\$4,594	£3,572	€4,109	\$5,002	£3,577	€4,115	\$5,009
Clear lacquered frame									
TBMD18X10/CLQ/	£3,179	€3,656	\$4,450	£3,464	€3,984	\$4,850	£3,473	€3,994	\$4,862
TBMD20X10/CLQ/	£3,224	€3,708	\$4,514	£3,511	€4,038	\$4,916	£3,520	€4,049	\$4,929
TBMD24X10/CLQ/	£3,281	€3,774	\$4,594	£3,572	€4,109	\$5,002	£3,577	€4,115	\$5,009

Dimensions : Height 730mm | Width 1,800/2,000/2,400mm | Depth 1,000mm | Weight 124/135/145kg



Poseur - 1,060mm height, with power

Product Code: TBMP20X10/, TBMP24X10/

Description: Poseur height table with black painted or clear lacquered RSJ frame. Available with a laminate, soft touch or rustic natural or grey stained wood top. Plus a choice of Surface (P) or Pandora (D) power. Available in 2,000 & 2,400mm widths.

Prices	Laminate top Surface (P) Pandora (D)			Fenix Top Surface (P) Pandora (D)			Rustic Natural Wood Veneered Top Surface (P) Pandora (D)		
	£	€	\$	£	€	\$	£	€	\$
Black painted frame									
TBMP20X10/BLK/	£3,440	€3,957	\$4,817	£3,731	€4,291	\$5,224	£3,736	€4,297	\$5,231
TBMP24X10/BLK/	£3,483	€4,006	\$4,877	£3,774	€4,341	\$5,285	£3,779	€4,347	\$5,292
Clear lacquered frame									
TBMP20X10/CLQ/	£3,440	€3,957	\$4,817	£3,731	€4,291	\$5,224	£3,736	€4,297	\$5,231
TBMP24X10/CLQ/	£3,483	€4,006	\$4,877	£3,774	€4,341	\$5,285	£3,779	€4,347	\$5,292

Dimensions : Height 1,060mm | Width 2,000/2,400mm | Depth 1,000mm | Weight 147/157kg



Product Code: TBMP30X10/, TBMP36X10/, TBMP40X10

Description: Large poseur height table with black painted or clear lacquered RSJ frame. Available with a laminate, soft touch or rustic natural or grey stained wood top. Addition of a central leg for core strength. Plus a choice of Surface (P) or Pandora (D) power. Available in 3,000, 3,600 & 4,000mm widths.

Prices	Laminate Top Surface (P) Pandora (D)			Fenix Top Surface (P) Pandora (D)			Rustic Natural Wood Veneered Top Surface (P) Pandora (D)		
	£	€	\$	£	€	\$	£	€	\$
Black painted frame									
TBMP30X10/BLK/	£5,004	€5,755	\$7,006	£5,390	€6,199	\$7,547	£5,832	€6,708	\$8,166
TBMP36X10/BLK/	£5,269	€6,060	\$7,377	£5,798	€6,669	\$8,118	£5,890	€6,774	\$8,246
TBMP40X10/BLK/	£5,296	€6,091	\$7,415	£5,839	€6,715	\$8,175	£5,931	€6,821	\$8,303
Clear lacquered frame									
TBMP30X10/CLQ/	£5,004	€5,755	\$7,006	£5,390	€6,199	\$7,547	£5,832	€6,708	\$8,166
TBMP36X10/CLQ/	£5,269	€6,060	\$7,377	£5,798	€6,669	\$8,118	£5,890	€6,774	\$8,246
TBMP40X10/CLQ/	£5,296	€6,091	\$7,415	£5,839	€6,715	\$8,175	£5,931	€6,821	\$8,303

Dimensions : Height 1,060mm | Width 3,000/3,600/4,000mm | Depth 1,000mm | Weight 187/215/230kg



Please note: Both Surface Power (P) and Pandora Power (D) are available with this product and need to be indicated using the bracketed letter at the end of your chosen product code.



Beam With Power (Options)

Power

Power Code	Description	Visual	Surface Power (P)			Pandora Power (D)								
			DINER BMPOWPKD	POSEUR BMPOWPKP	DINER BMPOWPKP	DINER BMPOWPKP	POSEUR BMPOWPKP	DINER BMPOWPKD	POSEUR BMPOWPKD					
Type A	3 UK fused power sockets		£608	€700	\$852	£660	€759	\$924	£315	€363	\$441	£367	€423	\$514
Type C	1 dual CAT6 unshielded data socket & 2 UK fused power sockets		£858	€987	\$1,202	£910	€1,047	\$1,274	£521	€600	\$730	£573	€659	\$803
Type D	1 dual USB charger & 2 UK fused power sockets		£828	€953	\$1,160	£888	€1,022	\$1,244	£444	€511	\$622	£496	€571	\$695
Type E	1 dual CAT6 unshielded data, 1 dual USB charger & 1 UK fused power socket		£1,218	€1,401	\$1,706	£1,270	€1,461	\$1,778	£550	€633	\$770	£602	€693	\$843
Type F	1 HDMI, 1 dual USB charger & 1 UK fused power socket		£1,418	€1,631	\$1,986	£1,470	€1,691	\$2,058	£829	€954	\$1,161	£881	€1,014	\$1,234

Please note: Beam Power includes 5m mains cable and black pathfinder trunking from underside of table to the floor per unit.

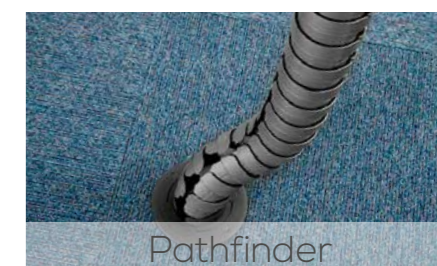
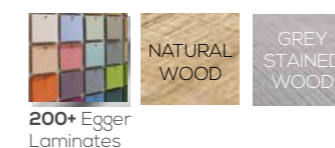
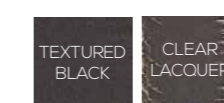

Table Top Finishes



Metal Finishes



Co.Table

Coworking table with poseur end and Centro stools



Integrated Power Options



Utility Rail & Lighting



Laminate or Melamine Tops



D End



Square End

Co.Table Meeting Tables



Meeting Tables - 750mm height, laminate top

Solid oak diner height meeting table with a laminate chamfered edge top and D-shaped or square ends. Options include integrated power and lighting with 4 cable managed legs. Black and Wenge stained options also available

Please note: pricing is for the power or power & light rail only, to add integrated power or power & light please see page 235

		Plain Top (PN)			Power Rail (PW)			Power & Light Rail (PL)			Black Stained Oak Wenge Stained Oak		
D Ends		£	€	\$	£	€	\$	£	€	\$	£	€	\$
Product Code	Dims												
TCB26DL/	2600mmx1265mm	£2,972	€3,418	\$4,161	£3,903	€4,489	\$5,465	£3,903	€4,489	\$5,465	+£437	+€503	+\$612
TCB32DL/	3200mmx1265mm	£3,372	€3,878	\$4,721	£4,610	€5,302	\$6,454	£4,610	€5,302	\$6,454	+£497	+€572	+\$696
TCB40DL/	4000mmx1265mm	£3,772	€4,338	\$5,281	£5,030	€5,785	\$7,042	£5,030	€5,785	\$7,042	+£577	+€664	+\$808
Square Ends													
TCB26SL/	2600mmx1265mm	£2,972	€3,418	\$4,161	£3,903	€4,489	\$5,465	£3,903	€4,489	\$5,465	+£437	+€503	+\$612
TCB32SL/	3200mmx1265mm	£3,372	€3,878	\$4,721	£4,610	€5,302	\$6,454	£4,610	€5,302	\$6,454	+£497	+€572	+\$696
TCB40SL/	4000mmx1265mm	£3,772	€4,338	\$5,281	£5,030	€5,785	\$7,042	£5,030	€5,785	\$7,042	+£577	+€664	+\$808

Meeting Tables - 750mm height, melamine top

Solid oak diner height meeting table with an MFMDf chamfered edge top and D-shaped or square ends. Options include integrated power and lighting with 4 cable managed legs. Black and Wenge stained options also available

Please note: pricing is for the power or power & light rail only, to add integrated power or power & light please see page 235

		Plain Top (PN)			Power Rail (PW)			Power & Light Rail (PL)			Black Stained Oak Wenge Stained Oak		
D Ends		£	€	\$	£	€	\$	£	€	\$	£	€	\$
Product Code	Dims												
TCB26DM/	2600mmx1265mm	£2,756	€3,170	\$3,859	£3,688	€4,242	\$5,164	£3,688	€4,242	\$5,164	+£437	+€503	+\$612
TCB32DM/	3200mmx1265mm	£3,025	€3,479	\$4,235	£4,275	€4,917	\$5,985	£4,275	€4,917	\$5,985	+£497	+€572	+\$696
TCB40DM/	4000mmx1265mm	£3,293	€3,787	\$4,611	£4,706	€5,412	\$6,589	£4,706	€5,412	\$6,589	+£577	+€664	+\$808
Square Ends													
TCB26SM/	2600mmx1265mm	£2,756	€3,170	\$3,859	£3,688	€4,242	\$5,164	£3,688	€4,242	\$5,164	+£437	+€503	+\$612
TCB32SM/	3200mmx1265mm	£3,025	€3,479	\$4,235	£4,275	€4,917	\$5,985	£4,275	€4,917	\$5,985	+£497	+€572	+\$696
TCB40SM/	4000mmx1265mm	£3,293	€3,787	\$4,611	£4,706	€5,412	\$6,589	£4,706	€5,412	\$6,589	+£577	+€664	+\$808

Legs & Edge

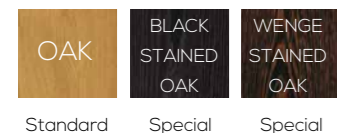

Standard Laminate

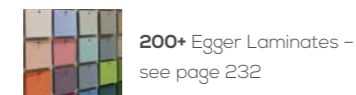

Standard Melamine (MFMDf)



Workbenches - 750mm height

Solid oak diner height workbench with an MFC 2mm PVC edge top and D-shaped or square ends. Options include integrated power and lighting with 4 cable managed legs. Black and Wenge stained options also available

Please note: pricing is for the power or power & light rail only, to add integrated power or power & light please see page 235

		Plain Top (PN)			Power Rail (PW)			Power & Light Rail (PL)			Black Stained Oak Wenge Stained Oak		
D Ends		£	€	\$	£	€	\$	£	€	\$	£	€	\$
Product Code	Dims												
TCW26DM/	2600mmx1600mm	£3,407	€3,919	\$4,770	£4,813	€5,535	\$6,739	£4,813	€5,535	\$6,739	+£569	+€655	+\$797
TCW32DM/	3200mmx1600mm	£4,100	€4,715	\$5,740	£5,675	€6,527	\$7,945	£5,675	€6,527	\$7,945	+£656	+€755	+\$919
TCW40DM/	4000mmx1600mm	£4,745	€5,457	\$6,643	£6,005	€6,906	\$8,407	£6,005	€6,906	\$8,407	+£750	+€863	+\$1050
Square Ends													
TCW26SM/	2600mmx1600mm	£3,407	€3,919	\$4,770	£4,813	€5,535	\$6,739	£4,813	€5,535	\$6,739	+£569	+€655	+\$797
TCW32SM/	3200mmx1600mm	£4,100	€4,715	\$5,740	£5,675	€6,527	\$7,945	£5,675	€6,527	\$7,945	+£656	+€755	+\$919
TCW40SM/	4000mmx1600mm	£4,745	€5,457	\$6,643	£6,005	€6,906	\$8,407	£6,005	€6,906	\$8,407	+£750	+€863	+\$1050

Legs & Edge

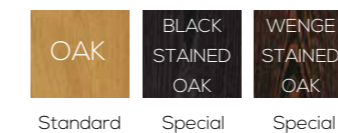

Standard Melamine (MFC)



Co.Table CoWorking Tables



CoWorking Tables - 750mm diner height, 1,060mm poseur end height, laminate top

Solid oak multi-height coworking table with a laminate chamfered edge top. Options include integrated power and lighting with 4 cable managed legs. Black and Wenge stained options also available

Product Code	Dims	Plain Top (PN)			Power Rail (PW)			Power & Light Rail (PL)			Black Stained Oak Wenge Stained Oak			Overall Width	Diner Depth	Poseur Depth
		£	€	\$	£	€	\$	£	€	\$	£	€	\$			
TCB26PL/	2600mmx1265mm	£6,150	€7,073	\$8,610	£7,145	€8,217	\$10,003	£7,145	€8,217	\$10,003	+£791	+€910	+\$1,108	3,425mm	1,265mm	1,495mm
TCB32PL/	3200mmx1265mm	£6,650	€7,648	\$9,310	£7,750	€8,913	\$10,850	£7,750	€8,913	\$10,850	+£851	+€979	+\$1,192	4,210mm	1,265mm	1,495mm
TCB40PL/	4000mmx1265mm	£7,110	€8,177	\$9,954	£8,279	€9,521	\$11,591	£8,279	€9,521	\$11,591	+£931	+€1,071	+\$1,304	4,815mm	1,265mm	1,495mm

CoWorking Tables - 750mm diner height, 1,060mm poseur end height, melamine top

Solid oak multi-height coworking table with an MFMDf chamfered edge top. Options include integrated power and lighting with 4 cable managed legs. Black and Wenge stained options also available

Please note: pricing is for the power or power & light rail only, to add integrated power or power & light please see page 235

Product Code	Dims	Plain Top (PN)			Power Rail (PW)			Power & Light Rail (PL)			Black Stained Oak Wenge Stained Oak			Overall Width	Diner Depth	Poseur Depth
		£	€	\$	£	€	\$	£	€	\$	£	€	\$			
TCB26PM/	2600mmx1265mm	£5,250	€6,038	\$7,350	£6,268	€7,209	\$8,776	£6,268	€7,209	\$8,776	+£791	+€910	+\$1,108	3,425mm	1,265mm	1,495mm
TCB32PM/	3200mmx1265mm	£5,510	€6,337	\$7,714	£6,750	€7,763	\$9,450	£6,750	€7,763	\$9,450	+£851	+€979	+\$1,192	4,210mm	1,265mm	1,495mm
TCB40PM/	4000mmx1265mm	£5,950	€6,843	\$8,330	£7,151	€8,224	\$10,012	£7,151	€8,224	\$10,012	+£931	+€1,071	+\$1,304	4,815mm	1,265mm	1,495mm

Legs & Edge

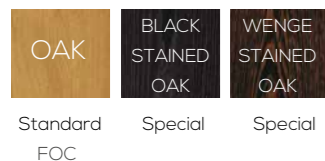

Standard Laminate

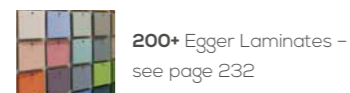

Standard Melamine (MFMDf)

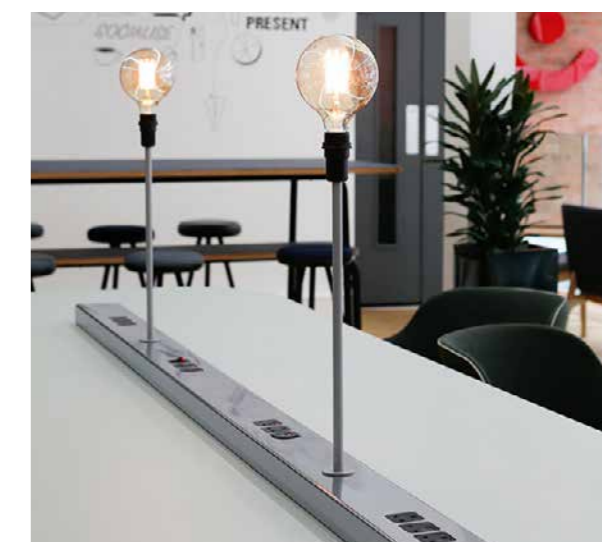

Lamp set up (x2 stems plus wiring, light bulbs are not supplied)

TYPE	COPOWER2 2 Power Modules			COPOWER3 3 Power Modules		
	£	€	\$	£	€	\$
TYPE A	£314	€362	\$440	£471	€542	\$660
TYPE C	£598	€688	\$838	£897	€1,032	\$1,256
TYPE D	£482	€555	\$675	£723	€832	\$1,013
TYPE E	£810	€932	\$1,134	£1,215	€1,398	\$1,701
TYPE F	£1,026	€1,180	\$1,437	£1,539	€1,770	\$2,155

	£	€	\$
COLIGHTS2/	£266	€306	\$373

Utility Rail & Light

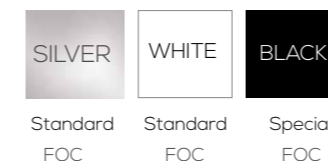

Power



See pg 235

Power modules

2,600mm - 2 x power modules
3,200mm - 2 x power modules
4,000mm - 3 x power modules

Tubes

Poseur table & bar stools in RAL colours



Design by Ratio Design Associates



Laminate Exposed Plywood Edge Top

MFC 2mm PVC Ply Effect Edged Top



Cable Management

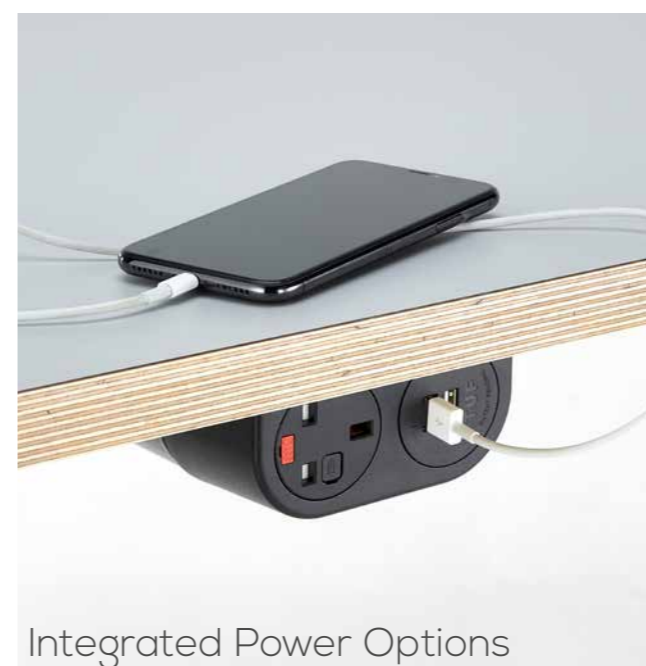

Integrated Power Options

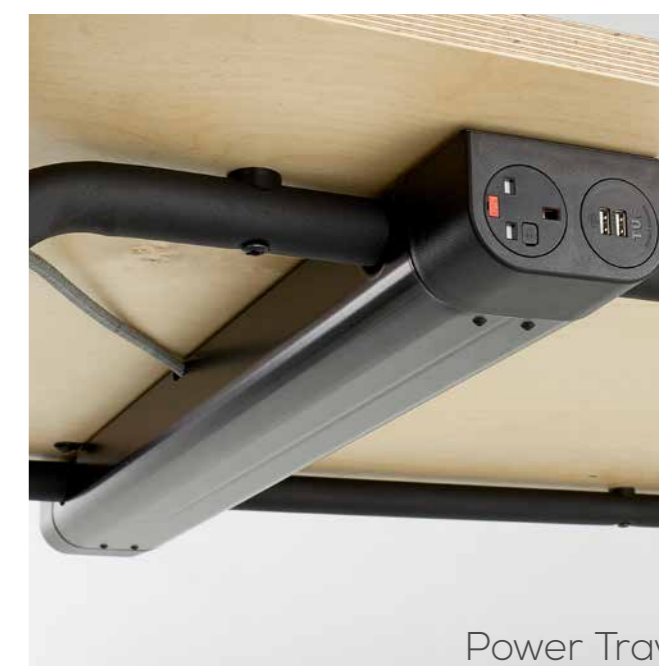

Power Tray

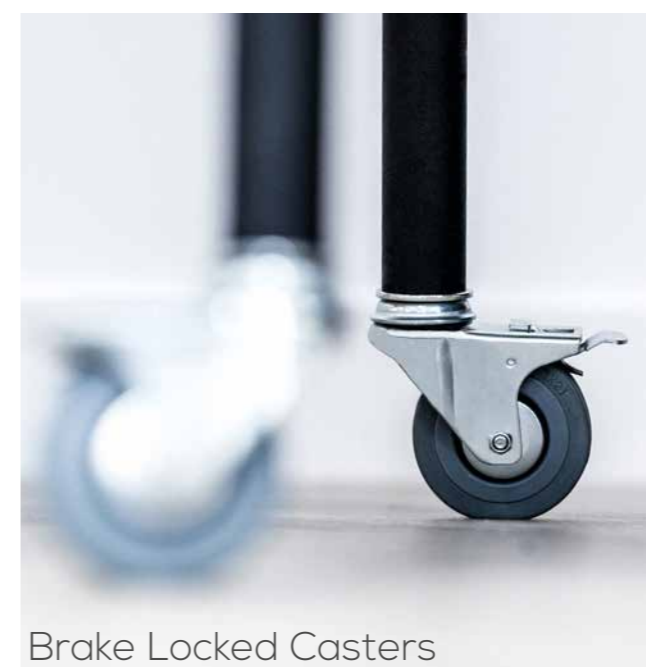

Brake Locked Casters



Coat Hooks

Tubes Diner Tables

Tubes Poseur Tables

Matching Seating:
 Tubes chairs pg 167
 Tubes stools & benches pg 176



Diner - 720mm height

Diner height tables with plywood top & steel tubular leg frame

Diner	Laminate top	£			€			\$			Depth
		Model	Price	Price	Price	Price	Price	Price	Price		
1,000 square diner table	TTLDI/S10	£1,171	€1,347	\$1,640	TTMDI/S10	£959	€1,103	\$1,343	-		
1,200 square diner table	TTLDI/S12	£1,174	€1,351	\$1,644	TTMDI/S12	£984	€1,132	\$1,378	-		
1,000 round diner table	TTLDI/R10	£1,188	€1,367	\$1,664	TTMDI/R10	£981	€1,129	\$1,374	1,000mm		
1,200 round diner table	TTLDI/R12	£1,191	€1,370	\$1,668	TTMDI/R12	£1,026	€1,180	\$1,437	1,200mm		

Matching Seating:
 Tubes chairs pg 167
 Tubes stools & benches pg 176



Poseur - 1,050mm height

Poseur height tables with plywood top, steel tubular leg frame & optional shelf

Poseur	Laminate top	£			€			\$			Depth	Weight
		Model	Price	Price	Price	Price	Price	Price	Price			
2,000 slim poseur table	TTLPI/N20	£1,714	€1,896	\$2,308	TTMPI/N20	£1,178	€1,303	\$1,587	650mm	60kg		
2,000 wide poseur table	TTLPI/W20	£2,102	€2,325	\$2,830	TTMPI/W20	£1,344	€1,486	\$1,809	1,000mm	70kg		
2,000 wide poseur with shelf	TTLPI2/W20	£3,035	€3,356	\$4,086	TTMPI2/W20	£1,825	€2,019	\$2,457	1,000mm	78kg		

Additional Options	£	€	\$
4 x brake locked casters per table	+£134	+€149	+\$181

Power Options	£	€	\$
Slim Table Power tray 2 x sockets with dual USB	+£696	+€801	+\$975
Slim Table Power tray 4 x sockets	+£466	+€536	+\$653
Wide Table Power tray 2 x sockets with dual USB	+704	+€810	+\$986
Wide Table Power tray 4 x sockets	+£474	+€546	+\$664

Please note: All power options are only available in black.

Standard Laminate

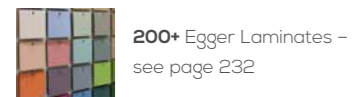

Standard Melamine (MFC)



Metal

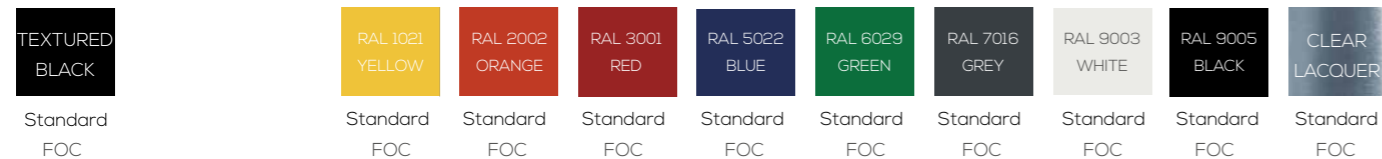

Standard Laminate

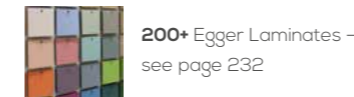

Standard Melamine (MFC)

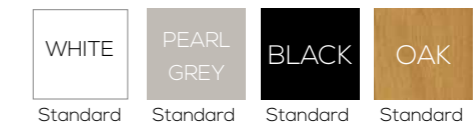

Metal



Tubes

Diner workbench with grey stained rustic top, low stool & bench



Tubes Diner Workbenches



Diner - 720mm height

Diner height workbenches with plywood top & steel tubular leg frame

Diner	Laminate top	MFC top			Rustic top			Depth					
		£	€	\$	£	€	\$						
1,800mm dining workbench	TTLDI/B18	£1,832	€2,107	\$2,565	TTMDI/B18	£1,676	€1,928	\$2,347	TTSDI/B18	£2,151	€2,474	\$3,012	1,200mm
2,400mm dining workbench	TTLDI/B24	£1,925	€2,214	\$2,695	TTMDI/B24	£1,762	€2,027	\$2,467	TTSDI/B24	£2,250	€2,588	\$3,150	1,200mm
3,000mm dining workbench	TTLDI/B30	£2,571	€2,957	\$3,600	TTMDI/B30	£2,374	€2,731	\$3,324	TTSDI/B30	£3,379	€3,771	\$4,591	1,200mm
3,600mm dining workbench	TTLDI/B36	£2,802	€3,223	\$3,923	TTMDI/B36	£2,484	€2,858	\$3,479	TTSDI/B36	£3,394	€3,904	\$4,752	1,200mm

Additional Options	£	€	\$
4 x brake locked casters per table	+£134	+€149	+\$181

Power Options	£	€	\$
Wide Table Power tray 2 x sockets with dual USB	+£704	+€810	+\$986
Wide Table Power tray 4 x sockets	+£474	+€546	+\$664

Please note: All power options are only available in black.

Standard Laminate

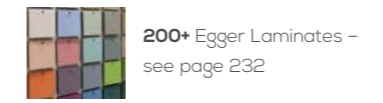

Standard Melamine (MFC)

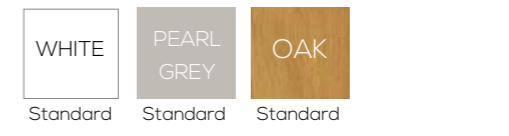

Wood



Metal

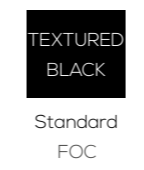

RAL Metal

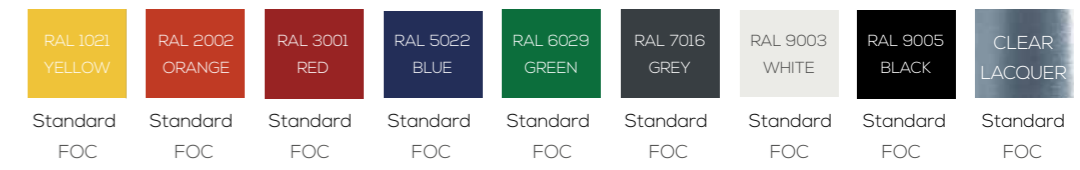

Connect

Folding & stackable meeting table



Silver base



Black casters

Connect

Product Code: TISRFC

Description: Meeting table with rectangular white folding top, silver base & black casters. Tables can be linked together with connector kit (available for an extra charge).

Certification: BS EN 15372: 2008

Dimensions	Product Code - White	£	€	\$
1,600x800mm	TISRFC/1600X800WH/SI	£575	€662	\$805



Product Code: TISRFC

Description: Meeting table with rectangular white folding top, silver base & black casters. Tables can be linked together with connector kit (available for an extra charge)

Certification: BS EN 15372: 2008

Dimensions	Product Code - White	£	€	\$
1,200x600mm	TISRFC/1200X600WH/SI	£566	€651	\$793
1,400x700mm	TISRFC/1400X700WH/SI	£570	€656	\$798



Additional Options:	£	€	\$
Connector Kit	+£40	+€44	+\$51



Omni

Product Code: TRLC/RND07500AB

Description: 750mm round coffee table with oak veneer plywood top and solid oak 4 leg broomstick base. Black and Wenge stained options also available

Price	£	€	\$
Oak	£439	€486	\$591
Black/Wenge Stained Oak	+£260	+€289	+\$351

Dimensions	
Height	365mm
Diameter	750mm
Weight	9kg



Seating options:

Hygge	pg 70-72
Rollie	pg 87-88
Korus	pg 90-92

Available options:

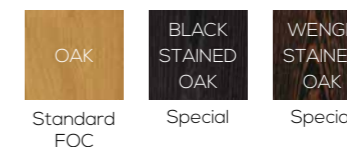

Dixi Wooden

Product Code: TDXC/OAK (Oak table) TDXC/WAL (Walnut table)

Description: Coffee table with solid planked oak or walnut top & solid oak or walnut 4 leg base

Price	£	€	\$
Oak	£753	€833	\$1,014
Walnut	£1,250	€1,388	\$1,688
Black/Wenge Stained Oak	+£260	+€289	+\$351

Dimensions	
Height	290mm
Diameter	640mm
Weight	15kg



Matching seating:

Dixi	pg 76-78
------	----------

Available Options:

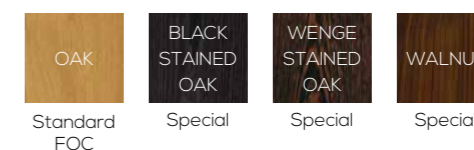

Dixi Cage

Product Code: TDXC/LAMBLK

Description: Coffee table with black laminate top and chrome, black or copper metal effect cage base

Price	£	€	\$
	£751	€831	\$1,011
Warm Metallic Copper Base	+£78	+€87	+\$122

Dimensions	
Height	285mm
Diameter	640mm
Weight	10kg



Matching seating:

Dixi	pg 76-78
------	----------

Available options:

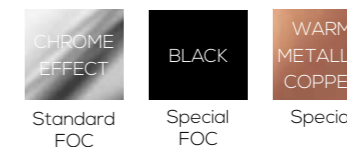

Gloss 4-star

Coffee



Glass top

Product Code: TGLC/RND0660GLX/CF4S

Coffee table with chrome effect 4-star base and 660mm round glass top.

Price £400 €460 \$560

Dimensions

Height 400mm
Diameter 660mm
Weight 12kg

Round MFC top

Product Code: TGLC/RND0750/CF4S

Coffee table with chrome effect 4-star base and 750mm round MFC top available in black, white or oak.

Price £328 €378 \$460

Dimensions

Height 400mm
Diameter 750mm
Weight 10kg

Squarial MFC top

Product Code: TGLC/SQU0750/CF4S

Coffee table with chrome effect 4-star base and 750mm squarial MFC top available in black, white or oak.

Price £328 €378 \$460

Dimensions

Height 400mm
Width 750mm
Depth 750mm
Weight 12kg

Diner



Product Code: TGLD/RND0800GLX/CF4S

Diner table with chrome effect 4-star base and 800mm round glass top.

Price £430 €495 \$602

Dimensions

Height 720mm
Diameter 800mm
Weight 15kg

Product Code: TGLD/RND0750/CF4S

Diner table with chrome effect 4-star base and 750mm or 900mm round MFC top available in black, white or oak.

Price £343 €395 \$481

Dimensions

Height 720mm
Diameter 750mm
Weight 12kg

Product Code: TGLD/RND0900

Price £375 €336 \$409

Dimensions

Height 720mm
Diameter 900mm
Weight 14kg

Product Code: TGLD/SQU0750/CF4S

Diner table with chrome effect 4-star base and 750mm squarial MFC top available in black, white or oak.

Price £343 €395 \$481

Dimensions

Height 720mm
Width 750mm
Depth 750mm
Weight 13kg

Poseur



Product Code: TGLP/RND0660GLX/CF4S

Poseur table with chrome effect 4-star base and 660mm round glass top.

Price £420 €483 \$588

Dimensions

Height 1,060mm
Diameter 660mm
Weight 14kg

Product Code: TGLP/RND0750/CF4S

Poseur table with chrome effect 4-star base and 750mm round MFC top available in black, white or oak.

Price £330 €380 \$462

Dimensions

Height 1,060mm
Diameter 750mm
Weight 12kg

Product Code: TGLP/SQU0750/CF4S

Poseur table with chrome effect 4-star base and 750mm squarial MFC top available in black, white or oak.

Price £364 €419 \$510

Dimensions

Height 1,060mm
Width 750mm
Depth 750mm
Weight 14kg

Gloss Wire

Product Code: TSWC/RND0660GLX/ (frosted safety glass)

Description: Coffee table with chrome effect wire base and 660mm round glass top

Price £410 €454 \$552

Frosted Safety Glass

Dimensions

Height 400mm
Diameter 660mm
Weight 8kg (MFC)
13kg (glass)



Product Code: TSWC/RND0750

Description: Coffee table with chrome effect wire base and 750mm round MFC top available in black, white or oak

Price £293 €325 \$395

Dimensions

Height 400mm
Diameter 750mm
Weight 10kg



Product Code: TSWC/SQU0750

Description: Coffee table with chrome effect wire base and 750mm squarial MFC top available in black, white or oak

Price £295 €327 \$398

Dimensions

Height 400mm
Width 750mm
Depth 750mm
Weight 10kg



Matching Seating:

- Kala** pg 83
- Rollie** pg 87
- Korus** pg 90
- Swoosh chairs** pg 93
- Swoosh sofas** pg 110
- Swoosh stools** pg 180

Metal



Standard FOC Special FOC Special FOC

Table Top

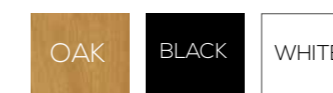

Standard FOC Standard FOC Standard FOC

Please note: black & white options available on wire bases only

Leo

Occasional table with matt black legs & Tryst sofa



Check | Leo | Mortimer

Check

Product Code: TCKC/RECXXXXOAV/CH4L (oak)

Description: Coffee table with rectangular veneer top and chrome effect 4 leg base. Black and Wenge stained options also available

Price	£	€	\$
Oak	£601	€665	\$810
Black/Wenge Stained Oak	+£260	+€289	+\$351

Dimensions	
Height	305mm
Width	1200mm
Depth	600mm
Weight	20kg



Matching Seating:
Check pg 97-98

Leo

Product Code: TLEC/REC/XXOAV

Description: Coffee table with oak veneer plywood top and matt black or chrome effect 4 leg metal base

Price	£	€	\$
	£779	€862	\$1,049

Dimensions	
Height	300mm
Width	1200mm
Depth	700mm
Weight	21kg



Matching Seating:
Leo pg 100

Mortimer

Product Code: TMOC/RECXXXXX/OA4L

Description: 1,200mm coffee table with oak veneer top and solid oak 4 leg base. Black and Wenge stained options also available

Price	£	€	\$
	£636	€704	\$857
Black/Wenge Stained Oak	+£260	+€289	+\$351

Dimensions	
Height	385mm
Width	1,200mm
Depth	600mm
Weight	13kg



Product Code: TMOC/TRIXXXXXX/OA3L

Description: 790mm coffee table with triangular oak veneer top and solid oak 3 leg base. Black and Wenge stained options also available

Price	£	€	\$
	£598	€662	\$805
Black/Wenge Stained Oak	+£260	+€289	+\$351

Dimensions	
Height	385mm
Width	790mm
Depth	790mm
Weight	11kg



Matching Seating:
Mortimer pg 102

Wood

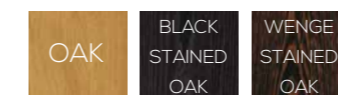

Standard FOC Special Special
Please note: staining options only available on Check & Mortimer tables

Metal

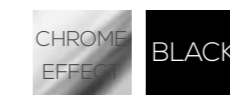

Standard FOC Standard FOC

Flow

Squarial table with curved black metal base

Occasional Tables

Flow



Product Code: TFL/750RND

Description: Multi-use table with a round laminate top and curved black metal base

Price	£	€	\$
	£492	€566	\$689

Dimensions	
Height	553mm
Diameter	750mm
Weight	9kg



Product Code: TFL/750SQU

Description: Multi-use table with a squarial laminate top and curved black metal base

Price	£	€	\$
	£492	€566	\$689

Dimensions	
Height	553mm
Diameter	750mm
Weight	12kg



Metal Finishes

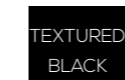

Standard
FOC

Standard Laminate



200+ Egger Laminates -
see page 232

Fusion

Laptop work table with Centro chair



Laptop Tables

Fusion

Product Code: TFS/RND/OAK/BLK

Description: Laptop work table with oak veneered plywood circular top and textured black metal base

Price	£	€	\$
	£397	€437	\$556

Dimensions

Height	660mm
Width	470mm
Depth	460mm
Weight	8kg



Product Code: TFS/SQU/OAK/BLK

Description: Laptop work table with oak veneered plywood square top and textured black metal base

Price	£	€	\$
	£397	€437	\$556

Dimensions

Height	660mm
Width	470mm
Depth	460mm
Weight	8kg



Product Code: TFS/OAK/OAK

Description: Laptop work table in solid oak

Price	£	€	\$
	£517	€595	\$724

Dimensions

Height	660mm
Width	420mm
Depth	370mm
Weight	4kg



Metal



Standard
FOC

Wood



Standard
FOC

Fusion

Laptop work table with Swoosh chair



Design by Luke Smoothy & Bethany Luscombe

Xpresso

Xpresso Family



Xpresso Original



Product Code: MXPID (Black Base) / MXPIA (Chrome Base)
Description: High density stacking chair with polypropylene seat and back, wire base and nylon glides.
Certification: BS EN 15373: 2007

Price	£	€	\$	Dimensions		Polypropylene Colour Options	
	£118	€130	\$159	Height	830mm	Black	MXPID/AA
				Width	580mm	White	MXPID/BB
				Depth	490mm	Cement Grey	MXPID/II
				Seat Height	460mm	Sand	MXPID/MM
				Seat Depth	425mm	Powder Blue	MXPID/YO
				Weight	5kg	Military Green	MXPID/ZP
						Marsala Red	MXPID/XN

Please note: black available on Quick ship (2-3 weeks) lead time.



Product Code: MXPIA (Chrome Base) / MXPID (Black Base)
Description: High density stacking chair with upholstered seat, polypropylene back, wire base and nylon glides.
Certification: BS EN 15373: 2007

Price	£	€	\$	Dimensions		Polypropylene Colour Options	
Group 0	£181	€201	\$244	Height	830mm	Black	MXPIA/AF
Group 1	£184	€204	\$248	Width	580mm	White	MXPIA/BF
Group 2	£196	€217	\$264	Depth	490mm	Cement Grey	MXPIA/IF
Group 3	£208	€230	\$280	Seat Height	460mm	Sand	MXPIA/MF
Group 4	£213	€236	\$287	Seat Depth	425mm	Powder Blue	MXPIA/YF
Group 5	£228	€252	\$307	Weight	8kg	Military Green	MXPIA/ZF
Group 6	£283	€313	\$381			Marsala Red	MXPIA/XF
Group 7	£308	€341	\$415				



Product Code: MXPIA/HF (Chrome Base) / MXPID/HF (Black Base)
Description: High density stacking chair with upholstered seat and back, wire base and nylon glides.
Certification: BS EN 15373: 2007

Price	£	€	\$	Dimensions	
Group 0	£206	€228	\$278	Height	830mm
Group 1	£213	€236	\$287	Width	580mm
Group 2	£233	€258	\$314	Depth	490mm
Group 3	£257	€285	\$346	Seat Height	460mm
Group 4	£267	€296	\$360	Seat Depth	425mm
Group 5	£294	€326	\$397	Weight	10kg
Group 6	£401	€444	\$541		
Group 7	£445	€493	\$600		

Please note: not available in vinyl.



Product Code: WRITING TABLET
Description: Black MDF writing tablet, available for all chair finishes. Available left or right-handed - please specify.

Price	£	€	\$	Dimensions	
	£140	€156	\$189	Width	100-305mm
				Depth	245-500mm

Metal Fabrics Polypropylene Colour Additional

CHROME BLACK  See pg 233
 BLACK WHITE CEMENT GREY SAND STONE POWDER BLUE MILITARY GREEN MARSALA RED LINKING FEET (LXP) FOC

Xpresso Original



Product Code: MXPIE (Black Base) / MXPIC (Chrome Base)
Description: High density stacking chair with black arms, polypropylene seat and back, wire base and nylon glides.
Certification: BS EN 15373: 2007

Price	£	€	\$	Dimensions		Polypropylene Colour Options	
	£188	€255	\$310	Height	830mm	Black	MXPIE/AA
				Width	595mm	White	MXPIE/BB
				Depth	490mm	Cement Grey	MXPIE/II
				Seat Height	460mm	Sand	MXPIE/MM
				Seat Depth	425mm	Powder Blue	MXPIE/YO
				Weight	7kg	Military Green	MXPIE/ZP
						Marsala Red	MXPIE/XN

Product Code: MXPIC (Chrome Base) / MXPIE (Black Base)
Description: High density stacking chair, black arms, upholstered seat, polypropylene back, wire base and nylon glides.
Certification: BS EN 15373: 2007

Price	£	€	\$	Dimensions		Polypropylene Colour Options	
Group 0	£271	€301	\$366	Height	830mm	Black	MXPIC/AF
Group 1	£275	€304	\$370	Width	580mm	White	MXPIC/BF
Group 2	£286	€317	\$385	Depth	490mm	Cement Grey	MXPIC/IF
Group 3	£298	€331	\$402	Seat Height	460mm	Sand	MXPIC/MF
Group 4	£306	€339	\$412	Seat Depth	425mm	Powder Blue	MXPIC/YF
Group 5	£319	€354	\$430	Weight	10kg	Military Green	MXPIC/ZF
Group 6	£374	€414	\$504			Marsala Red	MXPIC/XF
Group 7	£397	€440	\$535				

Product Code: MXPIC/HF (Chrome Base) / MXPIE/HF (Black Base)
Description: High density stacking chair with black arms, upholstered seat and back, wire base and nylon glides.
Certification: BS EN 15373: 2007

Price	£	€	\$	Dimensions	
Group 0	£297	€329	\$401	Height	830mm
Group 1	£306	€339	\$412	Width	595mm
Group 2	£323	€358	\$436	Depth	490mm
Group 3	£347	€385	\$468	Seat Height	460mm
Group 4	£359	€397	\$483	Seat Depth	425mm
Group 5	£385	€426	\$518	Weight	12kg
Group 6	£492	€544	\$663		
Group 7	£537	€594	\$723		

Please note: not available in vinyl.

Product Code: TROLLEYMP
Description: Trolley enabling stacking to 45 high or 30 high if upholstered.

Price	£	€	\$	Dimensions	
	£557	€605	\$737	Height	570mm
				Fully Stacked Height	2,200mm
				Width	660mm
				Depth	760mm



Metal Fabrics Polypropylene Colour Additional

CHROME BLACK  See pg 233
 BLACK WHITE CEMENT GREY SAND STONE POWDER BLUE MILITARY GREEN MARSALA RED LINKING FEET (LXP) FOC

Xpresso Perforated chairs



Product Code: MXPIA (Chrome Base) / MXPID (Black Base)
Description: High density stacking chair, polypropylene seat & perforated back, wire base & nylon glides.
Certification: BS EN 15372: 2007

Price	£	€	\$	Dimensions	Polypropylene Colour Options
	£118	€130	\$159	Height 830mm	Black MXPIA/NA
				Width 580mm	White MXPIA/OB
				Depth 490mm	Cement Grey MXPIA/SI
				Seat Height 460mm	Sand MXPIA/WM
				Seat Depth 425mm	Powder Blue MXPIA/2O
				Weight 5kg	Military Green MXPIA/3P
					Marsala Red MXPIA/IN



Product Code: MXPIA (Chrome Base) / MXPID (Black Base)
Description: High density stacking chair, upholstered seat, polypropylene perforated back, wire base & nylon glides.
Certification: BS EN 15372: 2007

Price	£	€	\$	Dimensions	Polypropylene Colour Options
Group 0	£181	€201	\$244	Height 830mm	Black MXPIA/NF
Group 1	£184	€204	\$248	Width 580mm	White MXPIA/OF
Group 2	£196	€217	\$264	Depth 490mm	Cement Grey MXPIA/SF
Group 3	£208	€230	\$280	Seat Height 460mm	Sand MXPIA/WF
Group 4	£213	€236	\$287	Seat Depth 425mm	Powder Blue MXPIA/2F
Group 5	£228	€252	\$307	Weight 8kg	Military Green MXPIA/3F
Group 6	£283	€313	\$381		Marsala Red MXPIA/1F
Group 7	£308	€341	\$415		



Product Code: MXPIE (Black Base) / MXPIC (Chrome Base)
Description: High density stacking chair, polypropylene seat & perforated back, wire base & nylon glides.
Certification: BS EN 15372: 2007

Price	£	€	\$	Dimensions	Polypropylene Colour Options
	£188	€255	\$310	Height 830mm	Black MXPIE/NA
				Width 595mm	White MXPIE/OB
				Depth 490mm	Cement Grey MXPIE/SI
				Seat Height 460mm	Sand MXPIE/WM
				Seat Depth 425mm	Powder Blue MXPIE/2O
				Weight 7kg	Military Green MXPIE/3P
					Marsala Red MXPIE/IN



Product Code: MXPIC (Chrome Base) / MXPIE (Black Base)
Description: High density stacking chair, black arms, upholstered seat, perforated back, wire base & nylon glides.
Certification: BS EN 15372: 2007

Price	£	€	\$	Dimensions	Polypropylene Colour Options
Group 0	£271	€301	\$366	Height 830mm	Black MXPIC/NF
Group 1	£275	€304	\$370	Width 595mm	White MXPIC/OF
Group 2	£286	€317	\$385	Depth 490mm	Cement Grey MXPIC/SF
Group 3	£298	€331	\$402	Seat Height 460mm	Sand MXPIC/WF
Group 4	£306	€339	\$412	Seat Depth 425mm	Powder Blue MXPIC/2F
Group 5	£319	€354	\$430	Weight 10kg	Military Green MXPIC/3F
Group 6	£374	€414	\$504		Marsala Red MXPIC/1F
Group 7	£397	€440	\$535		

Metal

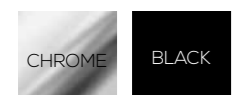

Fabrics



Polypropylene Colour



Additional



(LXP)
FOC

See pg 233

Xpresso Curve chairs



Product Code: MXPID (Black Base) / MXPIA (Chrome Base)
Description: High density stacking chair, polypropylene seat & curved back, wire base & nylon glides.
Certification: BS EN 15372: 2007

Price	£	€	\$	Dimensions	Polypropylene Colour Options
	£118	€130	\$159	Height 830mm	Black MXPID/4A
				Width 580mm	White MXPID/5B
				Depth 490mm	Cement Grey MXPID/6I
				Seat Height 460mm	Sand MXPID/7M
				Seat Depth 425mm	Powder Blue MXPID/9O
				Weight 5kg	Military Green MXPID/8P
					Marsala Red MXPID/10N

Product Code: MXPID (Black Base) / MXPIA (Chrome Base)
Description: High density stacking chair, upholstered seat, polypropylene curved back, wire base & nylon glides.
Certification: BS EN 15372: 2007

Price	£	€	\$	Dimensions	Polypropylene Colour Options
Group 0	£181	€201	\$244	Height 830mm	Black MXPID/4F
Group 1	£184	€204	\$248	Width 580mm	White MXPID/5F
Group 2	£196	€217	\$264	Depth 490mm	Cement Grey MXPID/6F
Group 3	£208	€230	\$280	Seat Height 460mm	Sand MXPID/7F
Group 4	£213	€236	\$287	Seat Depth 425mm	Powder Blue MXPID/9F
Group 5	£228	€252	\$307	Weight 8kg	Military Green MXPID/8F
Group 6	£283	€313	\$381		Marsala Red MXPID/10F
Group 7	£308	€341	\$415		



Product Code: MXPIE (Black Base) / MXPIC (Chrome Base)
Description: High density stacking chair, black arms, polypropylene seat and curved back, wire base & nylon glides.
Certification: BS EN 15372: 2007

Price	£	€	\$	Dimensions	Polypropylene Colour Options
	£188	€255	\$310	Height 830mm	Black MXPIE/4A
				Width 595mm	White MXPIE/5B
				Depth 490mm	Cement Grey MXPIE/6I
				Seat Height 460mm	Sand MXPIE/7M
				Seat Depth 425mm	Powder Blue MXPIE/9O
				Weight 7kg	Military Green MXPIE/8P
					Marsala Red MXPIE/10N



Product Code: MXPIC (Chrome Base) / MXPIE (Black Base)
Description: High density stacking chair, black arms, upholstered seat, polypropylene curved back, wire base & nylon glides.
Certification: BS EN 15372: 2007

Price	£	€	\$	Dimensions	Polypropylene Colour Options
Group 0	£271	€301	\$366	Height 830mm	Black MXPIC/4F
Group 1	£275	€304	\$370	Width 595mm	White MXPIC/5F
Group 2	£286	€317	\$385	Depth 490mm	Cement Grey MXPIC/6F
Group 3	£298	€331	\$402	Seat Height 460mm	Sand MXPIC/7F
Group 4	£306	€339	\$412	Seat Depth 425mm	Powder Blue MXPIC/9F
Group 5	£319	€354	\$430	Weight 10kg	Military Green MXPIC/8F
Group 6	£374	€414	\$504		Marsala Red MXPIC/10F
Group 7	£397	€440	\$535		



Metal

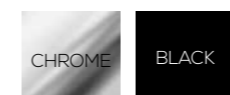

Fabrics



Polypropylene Colour



Additional



(LXP)
FOC

See pg 233

Xpresso High Chairs

Xpresso High Chairs & Accessories

Original



Product Code: GXPID (Black Base) / GXPIA (Chrome Base)
Description: High density stacking high chair with polypropylene seat and back, wire base and nylon glides. Stacks 5 high.
Certification: BS EN 15373: 2007

Price	£	€	\$	Dimensions		Polypropylene Colour Options	
	£183	€203	\$247	Height	1,070mm	Black	GXPID/AA
				Width	600mm	White	GXPID/BB
				Depth	490mm	Cement Grey	GXPID/II
				Seat Height	720mm	Sand	GXPID/MM
				Seat Depth	425mm	Powder Blue	GXPID/YO
				Weight	8kg	Military Green	GXPID/ZP
						Marsala Red	GXPID/XN

Product Code: GXPIA (Chrome Base) / GXPID (Black Base)
Description: High density stacking high chair with upholstered seat, polypropylene back, wire base and nylon glides.
Certification: BS EN 15373: 2007



Price	£	€	\$	Dimensions		Polypropylene Colour Options	
Group 0	£246	€274	\$332	Height	1,070mm	Black	GXPIA/AF
Group 1	£249	€277	\$336	Width	600mm	White	GXPIA/BF
Group 2	£261	€290	\$352	Depth	490mm	Cement Grey	GXPIA/IF
Group 3	£273	€303	\$368	Seat Height	720mm	Sand	GXPIA/MF
Group 4	£278	€309	\$375	Seat Depth	425mm	Powder Blue	GXPIA/YF
Group 5	£293	€325	\$395	Weight	8kg	Military Green	GXPIA/ZF
Group 6	£348	€386	\$469			Marsala Red	GXPIA/XF
Group 7	£373	€414	\$503				

Product Code: GXPID/HF (Black Base) / GXPIA/HF (Chrome Base)
Description: High density stacking high chair with fully upholstered seat, fully upholstered back, wire base & nylon glides. Stacks to 5 high.
Certification: BS EN 15373: 2007



Price	£	€	\$	Dimensions	
Group 0	£271	€300	\$365	Height	1,070mm
Group 1	£278	€308	\$375	Width	600mm
Group 2	£298	€330	\$402	Depth	490mm
Group 3	£322	€357	\$434	Seat Height	720mm
Group 4	£332	€368	\$448	Seat Depth	425mm
Group 5	£359	€398	\$484	Weight	8kg
Group 6	£466	€517	\$629		
Group 7	£510	€566	\$688		

Product Code: GXPID (Black Base) / GXPIA (Chrome Base)
Description: High density stacking high chair with polypropylene seat, perforated polypropylene back, wire base & nylon glides. Stacks to 5 high.
Certification: BS EN 15373: 2007

Price	£	€	\$	Dimensions		Polypropylene Colour Options	
	£183	€203	\$247	Height	1,070mm	Black	GXPID/NA
				Width	600mm	White	GXPID/OB
				Depth	490mm	Cement Grey	GXPID/SI
				Seat Height	720mm	Sand	GXPID/MM
				Seat Depth	425mm	Powder Blue	GXPID/2O
				Weight	8kg	Military Green	GXPID/3P
						Marsala Red	GXPID/IN

Perforated



Product Code: GXPIA (Chrome Base) / GXPID (Black Base)
Description: High density stacking high chair, black arms, upholstered seat, perforated back, wire base & nylon glides.
Certification: BS EN 15372: 2007

Price	£	€	\$	Dimensions		Polypropylene Colour Options	
Group 0	£246	€274	\$332	Height	1,070mm	Black	GXPIA/NF
Group 1	£249	€277	\$336	Width	600mm	White	GXPIA/OF
Group 2	£261	€290	\$352	Depth	490mm	Cement Grey	GXPIA/SF
Group 3	£273	€303	\$368	Seat Height	720mm	Sand	GXPIA/WF
Group 4	£278	€309	\$375	Seat Depth	425mm	Powder Blue	GXPIA/2F
Group 5	£293	€325	\$395	Weight	8kg	Military Green	GXPIA/3F
Group 6	£348	€386	\$469			Marsala Red	GXPIA/1F
Group 7	£373	€414	\$503				



Product Code: GXPIA (Chrome Base) / GXPID (Black Base)
Description: High density stacking high chair with polypropylene seat & curved back, wire base & nylon glides.
Certification: BS EN 15373: 2007

Price	£	€	\$	Dimensions		Polypropylene Colour Options	
	£183	€203	\$247	Height	1,070mm	Black	GXPIA/4A
				Width	600mm	White	GXPIA/5B
				Depth	490mm	Cement Grey	GXPIA/6I
				Seat Height	720mm	Sand	GXPIA/7M
				Seat Depth	425mm	Powder Blue	GXPIA/9O
				Weight	8kg	Military Green	GXPIA/8P
						Marsala Red	GXPIA/10N

Curve



Product Code: GXPIA (Chrome Base) / GXPID (Black Base)
Description: High density stacking high chair with upholstered seat, polypropylene back, wire base and nylon glides.
Certification: BS EN 15373: 2007

Price	£	€	\$	Dimensions		Polypropylene Colour Options	
Group 0	£246	€274	\$332	Height	1,070mm	Black	GXPIA/4F
Group 1	£249	€277	\$336	Width	600mm	White	GXPIA/5F
Group 2	£261	€290	\$352	Depth	490mm	Cement Grey	GXPIA/6F
Group 3	£273	€303	\$368	Seat Height	720mm	Sand	GXPIA/7F
Group 4	£278	€309	\$375	Seat Depth	425mm	Powder Blue	GXPIA/9F
Group 5	£293	€325	\$395	Weight	8kg	Military Green	GXPIA/8F
Group 6	£348	€386	\$469			Marsala Red	GXPIA/10F
Group 7	£373	€414	\$503				



Metal

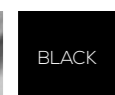

Fabrics



See pg 233

Polypropylene Colour

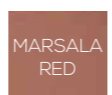
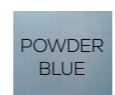
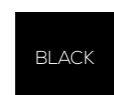

Additional



(LXP)
FOC

Metal

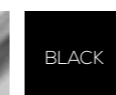
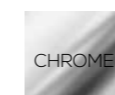

Fabrics



See pg 233

Polypropylene Colour

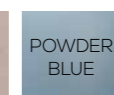
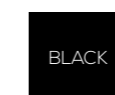

Additional



(LXP)
FOC

Session

High density stacking chairs with sled base & 4 leg base with arms

Work-Café Chairs

Session



Product Code: MSE/WIRBK

Description: High density stacking chair with polypropylene seat & rounded back, wire sled base with nylon glides. Available with a choice of 5 shell colours.

Price	£	€	\$	Dimensions	
	£145	€167	\$203	Height	800mm
				Width	530mm
				Depth	515mm
				Seat Height	450mm
				Weight	7kg



Product Code: MSE/4LXBK

Description: High density stacking chair with polypropylene seat & rounded back, 4 legged base with nylon glides. Available with a choice of 5 shell colours.

Price	£	€	\$	Dimensions	
	£150	€173	\$210	Height	800mm
				Width	545mm
				Depth	540mm
				Seat Height	450mm
				Weight	5kg



Product Code: MSE/4LABK

Description: High density stacking chair with arms, polypropylene seat & rounded back, 4 legged base with nylon glides. Available with a choice of 5 shell colours.

Price	£	€	\$	Dimensions	
	£170	€196	\$238	Height	800mm
				Width	580mm
				Depth	540mm
				Seat Height	450mm
				Weight	6kg



Metal



Polypropylene Colour

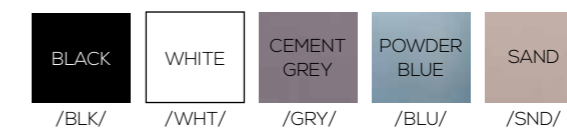

Luna

A curvaceous polypropylene chair

Work-Café Chairs

Luna Polypropylene



Product Code: MLU/XXX/4LX

Description: A distinctively curvaceous chair with a polypropylene shell on a black or white 4 legged base

Price	£	€	\$
	£225	€259	\$315

Dimensions

Height	800mm
Width	590mm
Depth	530mm
Seat Height	445mm
Weight	8kg



Product Code: MLU/XXX/WIR

Description: A distinctively curvaceous chair with a polypropylene shell on a black or white wire base

Price	£	€	\$
	£215	€248	\$301

Dimensions

Height	800mm
Width	590mm
Depth	530mm
Seat Height	445mm
Weight	7kg



Product Code: MLU/XXX/RCK

Description: A distinctively curvaceous chair with a polypropylene shell on black metal runner base

Price	£	€	\$
	£360	€414	\$504

Dimensions

Height	750mm
Width	590mm
Depth	745mm
Seat Height	390mm
Weight	9kg



Metal

WHITE	BLACK
Standard /WHT/	Standard /BLK/

Polypropylene Colour

WHITE	BLACK	PEACH	POWDER BLUE	SAND	MILITARY GREEN
Standard /WHT/	Standard /BLK/	Standard /PCH/	Standard /BLU/	Standard /SND/	Standard /MGR/

Laurel

Café chair with beech base



Work-Café Chairs

Laurel

Product Code: MLL1

Description: Café chair with polypropylene body & solid beech base.

Price	£	€	\$
	£251	€278	\$338

Dimensions	
Height	790mm
Width	500mm
Depth	520mm
Seat Height	430mm
Weight	4kg

Polypropylene Colour Options

White MLL1/AXXX	Silver MLL1/FXXX
Red MLL1/CXXX	Blue MLL1/HXXX
Green MLL1/DXXX	Anthracite MLL1/XXX
Yellow MLL1/EXXX	



Product Code: MLL2

Description: Café chair with polypropylene body & solid black stained beech base.

Price	£	€	\$
	£251	€278	\$338

Dimensions	
Height	790mm
Width	500mm
Depth	520mm
Seat Height	430mm
Weight	4kg

Polypropylene Colour Options

White MLL2/AXXX	Silver MLL2/FXXX
Red MLL2/CXXX	Blue MLL2/HXXX
Green MLL2/DXXX	Anthracite MLL2/XXX
Yellow MLL2/EXXX	



Please note: Our black metal cross piece has an 8 week leadtime

Wood



Standard
FOC

Special

Polypropylene Colour



Standard
FOC

Standard
FOC

Standard
FOC

Standard
FOC

Standard
FOC

Standard
FOC

Standard
FOC



Product Code: MCA1A

Description: A lightweight contemporary work-café chair with upholstered seat. Quick Ship available on Anthracite frame and Camira Xtreme Plus Havana upholstered seat only

Price	£	€	\$
	£176	€203	\$247

Lead time	Quick ship (2-3 weeks)

Dimensions	
Height	788mm
Width	441mm
Depth	467mm
Seat Height	460mm
Seat Depth	420mm
Weight	5kg



Product Code: MCA1

Description: A lightweight contemporary work-café chair with upholstered seat. Seven frame colours available

Price	£	€	\$
Group 0	£168	€194	\$236
Group 1	£176	€203	\$247
Group 2	£187	€216	\$262
Group 3	£195	€225	\$273

Price	£	€	\$
Group 4	£206	€237	\$289
Group 5	£220	€253	\$308
Group 6	£262	€302	\$367
Group 7	£289	€333	\$405

Dimensions	
Height	788mm
Width	441mm
Depth	467mm
Seat Height	460mm
Seat Depth	420mm
Weight	5kg



Frame Colours

						
Standard MCA1A	Standard MCA1B	Standard MCA1C	Standard MCA1D	Standard MCA1E	Standard MCA1F	Standard MCA1G

Fabrics



See pg 233

Centro Chairs

Oak dining chairs with Centro diner table

Work-Café Chairs

Centro chairs



Product Code: MCEI/XUP/OAK
Description: Oak dining chair, stacks to 5 high

Price	£	€	\$
	£395	€455	\$553

Dimensions	
Height	810mm
Width	490mm
Depth	510mm
Seat Height	475mm
Weight	5kg



Product Code: MCEI/UPH/OAK
Description: Oak dining chair with upholstered seat, stacks to 5 high

Price	£	€	\$
Group 0	£492	€566	\$689
Group 1	£498	€573	\$698
Group 2	£506	€582	\$709
Group 3	£512	€589	\$717
Group 4	£520	€598	\$728

Price	£	€	\$
Group 5	£530	€610	\$742
Group 6	£560	€644	\$784
Group 7	£580	€667	\$812

Dimensions	
Height	810mm
Width	490mm
Depth	510mm
Seat Height	480mm
Weight	5kg



Product Code: GCEI/XUP/OAK
Description: Oak high chair

Price	£	€	\$
	£595	€685	\$833

Dimensions	
Height	1,060mm
Width	470mm
Depth	510mm
Seat Height	770mm
Weight	6kg



Product Code: GCEI/UPH/OAK
Description: Oak high chair with upholstered seat

Price	£	€	\$
Group 0	£664	€764	\$930
Group 1	£670	€771	\$938
Group 2	£678	€780	\$950
Group 3	£684	€787	\$958
Group 4	£692	€796	\$969

Price	£	€	\$
Group 5	£702	€808	\$983
Group 6	£732	€842	\$1025
Group 7	£752	€865	\$1053

Dimensions	
Height	1,060mm
Width	470mm
Depth	510mm
Seat Height	775mm
Weight	6kg



Matching Tables:
Centro tables pg 117
Centro Lite tables pg 121

Wood



Standard
FOC

Fabrics



See pg 233

Tubes Chairs Wooden

Tubes Chairs Polypropylene



Product Code: MTO1A/A (black base), MTO1A/B (white base), MTO1A/C (chrome base)
Description: Chair with oak veneer plywood seat & back. 4 leg metal base is available in a chrome, black, white or RAL colour finish

Price	£	€	\$	Dimensions
Black or White	£344	€381	\$464	Height 815mm
Chrome/RAL colour	£364	€403	\$490	Width 450mm
				Depth 510mm
				Seat Height 470mm
				Weight 6kg



Product Code: MTO2A/A (black base), MTO2A/B (white base), MTO2A/C (chrome base)
Description: Chair with arms and oak veneer plywood seat & back. 4 leg metal base is available in a chrome, black or white only

Price	£	€	\$	Dimensions
Black or White	£388	€429	\$523	Height 815mm
Chrome	£409	€452	\$551	Width 580mm
				Depth 510mm
				Seat Height 470mm
				Weight 7kg

Please note: not available in RAL colours



Product Code: GTO1A/A (black base), GTO1A/B (white base), GTO1A/C (chrome base)
Description: Bar stool with oak veneer plywood seat & back. 4 leg metal base is available in a chrome, black, white or RAL colour finish

Price	£	€	\$	Dimensions
Black or White	£441	€488	\$594	Height 1,045mm
Chrome/RAL colour	£461	€510	\$621	Width 445mm
				Depth 525mm
				Seat Height 750mm
				Weight 8kg

Matching Tables:
 Tubes tables [pg 135](#)

Product Code: MTO1B/A (black base), MTO1B/B (white base), MTO1B/C (chrome base)
Description: Chair with plastic seat & back available in black or white. 4 leg metal base is available in a chrome, black, white or RAL colour finish

Price	£	€	\$	Dimensions
Black or White	£204	€226	\$275	Height 815mm
Chrome/RAL colour	£224	€248	\$301	Width 450mm
				Depth 510mm
				Seat Height 470mm
				Weight 5kg



Product Code: MTO2B/A (black base), MTO2B/B (white base), MTO2B/C (chrome base)
Description: Chair with arms and plastic seat & back available in black or white. 4 leg metal base is available in a chrome, black or white only

Price	£	€	\$	Dimensions
Black or White	£248	€274	\$334	Height 815mm
Chrome	£268	€297	\$362	Width 580mm
				Depth 510mm
				Seat Height 470mm
				Weight 6kg

Please note: not available in RAL colours



Product Code: GTO1B/A (black base), GTO1B/B (white base), GTO1B/C (chrome base)
Description: Bar stool with plastic seat & back available in black or white. 4 leg metal base is available in a chrome, black, white or RAL colour finish

Price	£	€	\$	Dimensions
Black or White	£303	€335	\$408	Height 1,045mm
Chrome/RAL colour	£321	€356	\$433	Width 445mm
				Depth 525mm
				Seat Height 750mm
				Weight 8kg

Matching Tables:
 Tubes tables [pg 135](#)



Seat & Back Metal

RAL Colours Not available on chairs with arms

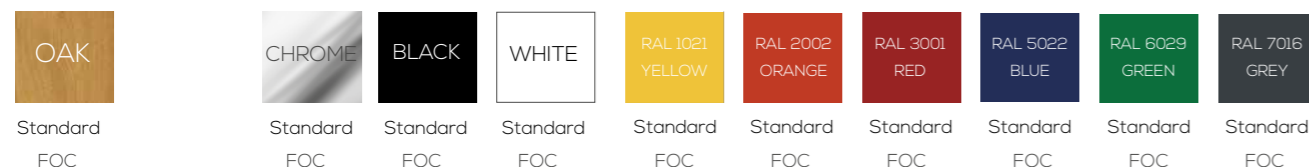

Seat & Back Metal

RAL Colours Not available on chairs with arms

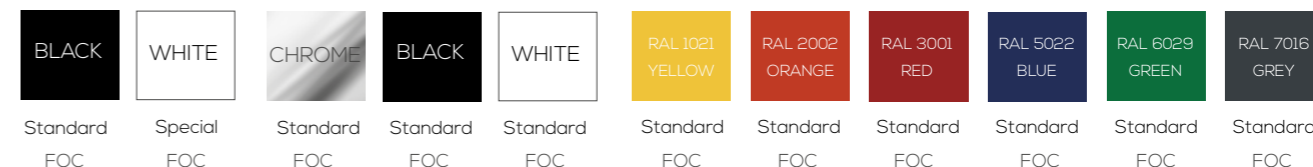

Tubes

Bar Stools & Table



Design by Ratio Design Associates

Centro

Bar stools & Centro Lite table



Design by Roger Webb Associates

Centro Stools & Benches



Product Code: GTR1

Description: Low stool with upholstered seat, button upholstery detail & solid oak 4 leg base. Black and Wenge stained options also available

Price

	£	€	\$
Group 3	£428	€474	\$577
Group 4	£435	€481	\$586
Group 5	£447	€495	\$602
Group 6	£500	€554	\$674
Group 7	£522	€578	\$703
Black Stained Oak	+£78	+€87	+\$106
Wenge Stained Oak	+£78	+€87	+\$106

Dimensions

Height	460mm
Diameter	380mm
Weight	9kg



Product Code: GTR2

Description: Bar stool with upholstered seat, button upholstery detail & solid oak 4 leg base with metal foot ring. Black and Wenge stained options also available

Price

	£	€	\$
Group 3	£509	€563	\$685
Group 4	£515	€570	\$693
Group 5	£527	€584	\$710
Group 6	£580	€642	\$782
Group 7	£602	€666	\$811
Black Stained Oak	+£94	+€105	+\$127
Wenge Stained Oak	+£94	+€105	+\$127

Dimensions

Height	760mm
Diameter	380mm
Weight	14kg



Product Code: STR1

Description: Bench with upholstered seat, button upholstery detail & solid oak 4 leg base. Black and Wenge stained options also available

Price

	£	€	\$
Group 3	£936	€1,035	\$1,260
Group 4	£947	€1,048	\$1,276
Group 5	£970	€1,073	\$1,307
Group 6	£1,065	€1,178	\$1,434
Group 7	£1,138	€1,259	\$1,532
Black Stained Oak	+£130	+€145	+\$176
Wenge Stained Oak	+£130	+€145	+\$176

Dimensions

Height	460mm
Width	1,300mm
Depth	420mm
Weight	15kg



Matching Tables:

Centro tables	pg 117
Centro Lite tables	pg 121

Metal



SILVER

Standard
FOC

Wood



OAK

Standard
FOC

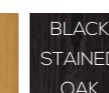

BLACK
STAINED
OAK

Special

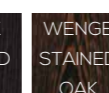

WENGE
STAINED
OAK

Special

Fabrics



See pg 233

Tubes

Low stools & slim bench



Tubes Stools & Benches

Product Code: GTB2

Description: Low stool with upholstered seat and black Valchromat seat base. Available with matt black or RAL colour finished 25mm steel tubular base.

Price	£	€	\$	Price	£	€	\$	Dimensions	
Group 0	£307	€354	\$430	Group 6	£388	€447	\$544	Height	510mm
Group 1	£312	€359	\$437	Group 7	£407	€469	\$570	Width	440mm
Group 2	£318	€366	\$446	Leather 1	£370	€426	\$518	Depth	440mm
Group 3	£328	€378	\$460	Leather 2	£402	€463	\$563	Seat Height	510mm
Group 4	£333	€383	\$467	Leather 3	£434	€500	\$608	Weight	5kg
Group 5	£343	€395	\$481						



Product Code: GTB1

Description: Bar stool with upholstered seat and black Valchromat seat base. Available with matt black or RAL colour finished 25mm steel tubular base.

Price	£	€	\$	Price	£	€	\$	Dimensions	
Group 0	£333	€368	\$448	Group 6	£413	€457	\$556	Height	750mm
Group 1	£338	€374	\$455	Group 7	£432	€478	\$581	Width	440mm
Group 2	£344	€381	\$464	Leather 1	£395	€437	\$532	Depth	440mm
Group 3	£354	€391	\$476	Leather 2	£427	€473	\$576	Seat Height	750mm
Group 4	£359	€397	\$483	Leather 3	£459	€508	\$618	Weight	8kg
Group 5	£369	€409	\$497						



Product Code: STB1/A

Description: Slim bench with upholstered seat and matt black or RAL colour finished 35mm steel tubular frame

Price	£	€	\$	Price	£	€	\$	Dimensions	
Group 0	£711	€787	\$958	Group 4	£800	€885	\$1,077	Height	480mm
Group 1	£729	€807	\$982	Group 5	£835	€924	\$1,125	Width	1,650mm
Group 2	£751	€831	\$1,011	Group 6	£985	€1,090	\$1,326	Depth	500mm
Group 3	£782	€865	\$1,053	Group 7	£1,047	€1,159	\$1,410	Seat Height	480mm
								Seat Depth	450mm
								Weight	20kg



Product Code: STB2/A

Description: Wide bench with upholstered seat and matt black or RAL colour finished 35mm steel tubular frame

Price	£	€	\$	Price	£	€	\$	Dimensions	
Group 0	£856	€947	\$1,153	Group 4	£970	€1,073	\$1,307	Height	480mm
Group 1	£879	€972	\$1,183	Group 5	£1,016	€1,124	\$1,368	Width	1,650mm
Group 2	£907	€1,003	\$1,221	Group 6	£1,211	€1,339	\$1,630	Depth	800mm
Group 3	£947	€1,048	\$1,276	Group 7	£1,291	€1,428	\$1,738	Seat Height	480mm
								Seat Depth	800mm
								Weight	30kg



Matching Tables:

Tubes tables [pg 135](#)

Metal

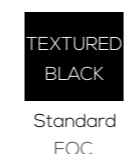

Fabrics



RAL Metal

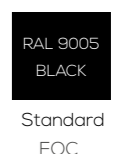
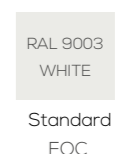
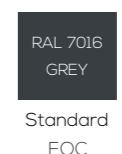
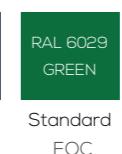
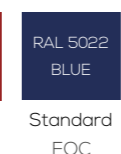
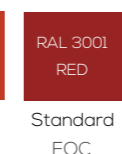
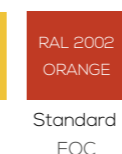
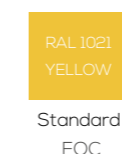

Tubes

Wide bench with writing tablet

Tubes Benches

Product Code: STB1/B

Description: Slim bench with upholstered seat and 1 writing tablet with laminate or melamine top. Available with matt black or RAL colour finished 35mm steel tubular base

Price	£	€	\$	Price	£	€	\$	Dimensions	
Group 0	£1,084	€1,199	\$1,459	Group 4	£1,172	€1,297	\$1,578	Height	710mm
Group 1	£1,101	€1,218	\$1,483	Group 5	£1,207	€1,336	\$1,626	Width	1,650mm
Group 2	£1,123	€1,242	\$1,512	Group 6	£1,357	€1,501	\$1,827	Depth	870mm
Group 3	£1,154	€1,277	\$1,554	Group 7	£1,420	€1,570	\$1,911	Seat Height	480mm
								Seat Depth	450mm
								Weight	23kg



Product Code: STB2/B

Description: Wide bench with upholstered seat and 1 writing tablet with laminate or melamine top. Available with matt black or RAL colour finished 35mm steel tubular base

Price	£	€	\$	Price	£	€	\$	Dimensions	
Group 0	£1,228	€1,359	\$1,654	Group 4	£1,343	€1,485	\$1,808	Height	710mm
Group 1	£1,251	€1,384	\$1,685	Group 5	£1,388	€1,536	\$1,869	Width	1,650mm
Group 2	£1,280	€1,416	\$1,724	Group 6	£1,583	€1,751	\$2,131	Depth	1,145mm
Group 3	£1,320	€1,460	\$1,777	Group 7	£1,663	€1,839	\$2,239	Seat Height	480mm
								Seat Depth	800mm
								Weight	33kg



Product Code: STB1/C

Description: Slim bench with upholstered seat and 2 writing tablets with laminate or melamine tops. Available with matt black or RAL colour finished 35mm steel tubular base

Price	£	€	\$	Price	£	€	\$	Dimensions	
Group 0	£1,437	€1,590	\$1,935	Group 4	£1,526	€1,688	\$2,054	Height	710mm
Group 1	£1,455	€1,609	\$1,959	Group 5	£1,561	€1,727	\$2,102	Width	1,650mm
Group 2	£1,477	€1,633	\$1,988	Group 6	£1,711	€1,892	\$2,303	Depth	1,235mm
Group 3	£1,508	€1,668	\$2,030	Group 7	£1,773	€1,961	\$2,387	Seat Height	480mm
								Seat Depth	450mm
								Weight	26kg



Product Code: STB2/C

Description: Wide bench with upholstered seat and 2 writing tablets with laminate or melamine tops. Available with matt black or RAL colour finished 35mm steel tubular base

Price	£	€	\$	Price	£	€	\$	Dimensions	
Group 0	£1,601	€1,770	\$2,155	Group 4	£1,715	€1,897	\$2,309	Height	710mm
Group 1	£1,623	€1,796	\$2,186	Group 5	£1,761	€1,947	\$2,371	Width	1,650mm
Group 2	£1,653	€1,828	\$2,225	Group 6	£1,955	€2,162	\$2,632	Depth	1,490mm
Group 3	£1,692	€1,872	\$2,278	Group 7	£2,028	€2,243	\$2,730	Seat Height	480mm
								Seat Depth	800mm
								Weight	36kg



Standard Laminate



200+ Egger Laminates - see page 232

Standard Melamine (MFC)



WHITE

Standard



PEARL GREY

Standard



OAK

Standard

Fabrics



See pg 233

Metal

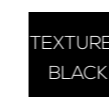

TEXTURED BLACK

Standard FOC

RAL Metal



RAL 1021 YELLOW

Standard FOC

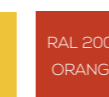

RAL 2002 ORANGE

Standard FOC



RAL 3001 RED

Standard FOC

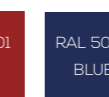

RAL 5022 BLUE

Standard FOC

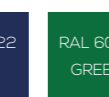

RAL 6029 GREEN

Standard FOC

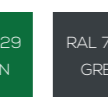

RAL 7016 GREY

Standard FOC

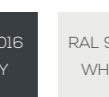

RAL 9003 WHITE

Standard FOC



RAL 9005 BLACK

Standard FOC



CLEAR LACQUER

Standard FOC

Swoosh

Bar stool with oak base



Swoosh stools

Product Code: GSWIX

Description: Bar stool with chrome effect, black or white metal wire base

Price	£	€	\$	Price	£	€	\$	Dimensions
Group 0	£393	€435	\$530	Group 6	£667	€738	\$898	Height 910mm
Group 1	£405	€448	\$545	Group 7	£711	€787	\$958	Width 460mm
Group 2	£417	€462	\$562	Leather 1	£544	€602	\$733	Depth 540mm
Group 3	£435	€481	\$586	Leather 2	£620	€686	\$835	Seat Height 750mm
Group 4	£444	€492	\$598	Leather 3	£698	€772	\$940	Weight 10kg
Group 5	£562	€621	\$756					



Product Code: GSWIF

Description: Bar stool with solid oak 4 leg base. Black and Wenge stained options also available

Price	£	€	\$	Price	£	€	\$	Dimensions
Group 0	£558	€618	\$752	Group 6	£753	€833	\$1,014	Height 910mm
Group 1	£576	€638	\$776	Group 7	£810	€896	\$1,091	Width 460mm
Group 2	£599	€663	\$807	Leather 1	£717	€793	\$965	Depth 540mm
Group 3	£616	€681	\$829	Leather 2	£797	€881	\$1,073	Seat Height 750mm
Group 4	£639	€707	\$860	Leather 3	£867	€960	\$1,168	Weight 9kg
Group 5	£668	€739	\$899	Black Stained Oak	+£165	+€184	+\$223	
				Wenge Stained Oak	+£165	+€184	+\$223	



Product Code: GSW3A

Description: Highback Bar stool with chrome effect, black or white metal wire base

Price	£	€	\$	Price	£	€	\$	Dimensions
Group 0	£463	€	\$	Group 6	£747	€	\$	Height 1,135mm
Group 1	£475	€	\$	Group 7	£791	€	\$	Width 460mm
Group 2	£487	€	\$	Leather 1	£614	€	\$	Depth 540mm
Group 3	£505	€	\$	Leather 2	£690	€	\$	Seat Height 750mm
Group 4	£519	€	\$	Leather 3	£768	€	\$	Weight 10kg
Group 5	£637	€	\$	Black Stained Oak	+£165	+€184	+\$223	
				Wenge Stained Oak	+£165	+€184	+\$223	

NEW



Product Code: GSW3F

Description: Highback bar stool with solid oak 4 leg base. Black and Wenge stained options also available

Price	£	€	\$	Price	£	€	\$	Dimensions
Group 0	£628	€	\$	Group 6	£833	€	\$	Height 1,135mm
Group 1	£646	€	\$	Group 7	£890	€	\$	Width 460mm
Group 2	£669	€	\$	Leather 1	£787	€	\$	Depth 540mm
Group 3	£686	€	\$	Leather 2	£867	€	\$	Seat Height 750mm
Group 4	£714	€	\$	Leather 3	£937	€	\$	Weight 9kg
Group 5	£743	€	\$	Black Stained Oak	+£165	+€184	+\$223	
				Wenge Stained Oak	+£165	+€184	+\$223	

NEW



Matching Tables:

Gloss [pg 143](#)

Metal

CHROME EFFECT	BLACK	WHITE
Standard FOC	Special FOC	Special FOC

Wood

OAK	BLACK STAINED OAK	WENGE STAINED OAK
Standard FOC	Special	Special

Fabrics



See pg 233

Platforms Box

Moveable seat with storage



Platforms Box

Product Code: SXX1

Description: Cube shape 25mm plywood stool with seat cushion, internal storage & casters

Price			Price			Dimensions			
	£	€	\$		£	€	\$		
Group 0	£301	€333	\$405	Group 4	£346	€383	\$467	Height	485mm
Group 1	£310	€343	\$418	Group 5	£363	€402	\$489	Width	400mm
Group 2	£323	€358	\$436	Group 6	£412	€456	\$555	Depth	400mm
Group 3	£334	€370	\$450	Group 7	£445	€493	\$600	Weight	10kg



Matching Range

Platforms [pg 13-16](#)

Platforms Additions [pg 17-22](#)

Price	£	€	\$
Black Stained Oak	+£30	+€34	+\$41

Wood



Standard
FOC

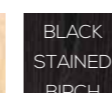

Special

Fabrics



See pg 233

Cubix

Upholstered stool

Cubix



Product Code: SCU/SQU

Description: Cube shaped upholstered stool with black feet. Options include casters and carry handle

Price	£	€	\$	Price	£	€	\$	Dimensions
Group 0	£169	€188	\$229	Group 4	£219	€244	\$296	Height 450mm
Group 1	£175	€195	\$237	Group 5	£239	€266	\$323	Width 450mm
Group 2	£189	€210	\$256	Group 6	£305	€339	\$412	Depth 450mm
Group 3	£209	€232	\$283	Group 7	£357	€397	\$482	Weight 11kg



Product Code: SCU/RND

Description: Cylinder shaped upholstered stool with black feet. Options include casters and carry handle

Price	£	€	\$	Price	£	€	\$	Dimensions
Group 0	£175	€195	\$237	Group 4	£217	€241	\$293	Height 450mm
Group 1	£180	€200	\$243	Group 5	£234	€260	\$316	Diameter 460mm
Group 2	£191	€213	\$258	Group 6	£285	€317	\$385	Weight 7kg
Group 3	£209	€232	\$283	Group 7	£343	€381	\$464	



Additional Options:

Price	£	€	\$
Casters	+£30	+€34	+\$41
Handle (tan leather)	+£30	+€34	+\$41

Fabrics



See pg 233

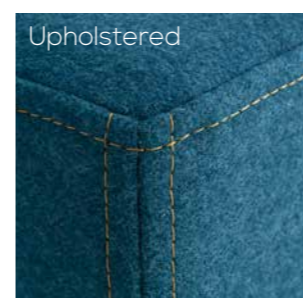

Upholstered

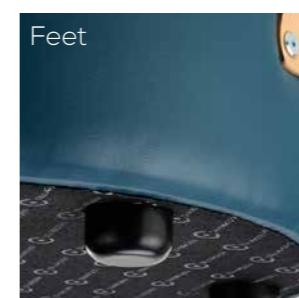

Feet



Carry Handle



Casters

Cubix

Upholstered stool



Cubix

Upholstered stool



Assemble

Low back with writing tablet, medium back and high back chairs



Design by Hilary Birkbeck



Assemble

Product Code: MAS/LOWX/CO (without writing tablet) MAS/LWT/CO (with writing tablet)
Description: Low back executive meeting chair with 4-star fixed base available in black or chrome. Plywood shell with oak veneer finish also available with black or wenge stain. Optional moveable writing tablet.

Without Writing Tablet

Price	£	€	\$
Group 0	£687	€791	\$962
Group 1	£699	€804	\$979
Group 2	£715	€823	\$1,001
Group 3	£727	€837	\$1,018
Group 4	£743	€855	\$1,041
Group 5	£763	€878	\$1,069
Group 6	£823	€947	\$1,153
Group 7	£863	€993	\$1,209

With Writing Tablet

Price	£	€	\$
Group 0	£989	€1,138	\$1,385
Group 1	£1,001	€1,152	\$1,402
Group 2	£1,017	€1,170	\$1,424
Group 3	£1,029	€1,184	\$1,441
Group 4	£1,045	€1,202	\$1,463
Group 5	£1,065	€1,225	\$1,491
Group 6	£1,125	€1,294	\$1,575
Group 7	£1,165	€1,340	\$1,631

Dimensions	
Height	844mm
Width	540mm
Seat Height	450mm
Seat Depth	470mm
Weight	12/13kg

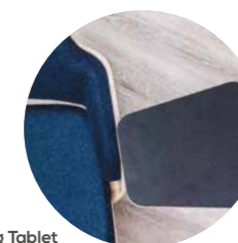

Writing Tablet



Product Code: MAS/MED

Description: Medium back executive meeting chair with 5-star swivel column base on castors, gas lift & tilt mechanism, available in black or chrome. Plywood shell with oak veneer finish also available with black or wenge stain.

Price	£	€	\$
Group 0	£854	€983	\$1,196
Group 1	£867	€998	\$1,214
Group 2	£885	€1,018	\$1,239
Group 3	£898	€1,033	\$1,258

Price	£	€	\$
Group 4	£916	€1,054	\$1,283
Group 5	£939	€1,080	\$1,315
Group 6	£1,005	€1,156	\$1,407
Group 7	£1,050	€1,208	\$1,470

Dimensions	
Height	1025-1055mm
Width	540mm
Seat Height	450-480mm
Seat Depth	470mm
Weight	14kg



Product Code: MAS/HIG

Description: High back executive meeting chair with headrest, 5-star swivel column base on castors, gas lift & tilt mechanism, available in black or chrome. Plywood shell with oak veneer finish also available with black or wenge stain.

Price	£	€	\$
Group 0	£963	€1,108	\$1,349
Group 1	£985	€1,133	\$1,379
Group 2	£1,016	€1,169	\$1,423
Group 3	£1,038	€1,194	\$1,454

Price	£	€	\$
Group 4	£1,069	€1,230	\$1,497
Group 5	£1,106	€1,272	\$1,549
Group 6	£1,220	€1,403	\$1,708
Group 7	£1,296	€1,491	\$1,815

Dimensions	
Height	1190-1220mm
Width	540mm
Seat Height	450-480mm
Seat Depth	470mm
Weight	16kg



Metal

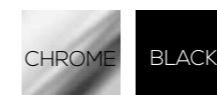

Standard FOC Standard FOC

Wood



Standard FOC Standard FOC Standard FOC

Writing Tablet Tops



Standard FOC Standard FOC

Fabrics



See pg 233

Muzia

Task chair with mesh back

Task Chairs

Muzia

Product Code: OMUIAA

Description: Task chair with black mesh back & upholstered seat in Camira Xtreme Plus Havana, adjustable lumbar, adjustable arms & a synchronised mechanism with hand-wheel tension control that locks in the upright position

Price	£	€	\$
	£267	€308	\$374

Lead time Quick ship
(2-3 weeks)

Dimensions	
Height	960-1080mm
Width	680mm
Depth	560mm
Seat Height	430-555mm
Seat Depth	480mm
Weight	11kg



Product Code: OMUIAA

Description: Task chair with black mesh back & upholstered seat, adjustable lumbar, adjustable arms & a synchronised mechanism with hand-wheel tension control that locks in the upright position

Price	£	€	\$
Group 0	£260	€299	364
Group 1	£267	€308	374
Group 2	£277	€319	388
Group 3	£285	€328	399

Price	£	€	\$
Group 4	£295	€340	413
Group 5	£307	€354	430
Group 6	£345	€397	483
Group 7	£370	€426	518

Dimensions	
Height	960-1080mm
Width	680mm
Depth	560mm
Seat Height	430-555mm
Seat Depth	480mm
Weight	11kg



Product Code: OMUIBB

Description: Task chair with black mesh back & upholstered seat in Camira Xtreme Plus Havana, adjustable lumbar, adjustable arms with sliding arm pad & an auto-synchronous mechanism that locks in 5 separate positions

Price	£	€	\$
	£297	€342	\$416

Lead time Quick ship
(2-3 weeks)

Dimensions	
Height	960-1080mm
Width	680mm
Depth	560mm
Seat Height	430-555mm
Seat Depth	480mm
Weight	11kg



Product Code: OMUIBB

Description: Task chair with black mesh back & upholstered seat, adjustable lumbar, adjustable arms with sliding arm pad & an auto-synchronous mechanism that locks in 5 separate positions

Price	£	€	\$
Group 0	£290	€334	\$406
Group 1	£297	€342	\$416
Group 2	£307	€354	\$430
Group 3	£315	€363	\$441

Price	£	€	\$
Group 4	£325	€374	\$455
Group 5	£337	€388	\$472
Group 6	£375	€432	\$525
Group 7	£400	€460	\$560

Dimensions	
Height	960-1080mm
Width	680mm
Depth	560mm
Seat Height	430-555mm
Seat Depth	480mm
Weight	11kg



Compito

Task chair with mesh back

Task Chairs

Compito



Product Code: OFFICEMESH

Description: Black task chair with mesh back and upholstered sliding seat. Adjustable back & arms and self-adjusting & lockable single synchronised mechanism as standard

Price	£	€	\$	Price	£	€	\$	Dimensions	
Group 0	£353	€406	\$495	Group 4	£402	€463	\$563	Height	1,000-1,120mm
Group 1	£363	€418	\$509	Group 5	£419	€482	\$587	Width	545mm
Group 2	£377	€434	\$528	Group 6	£472	€543	\$661	Depth	400-450mm
Group 3	£388	€447	\$544	Group 7	£507	€584	\$710	Seat Height	420-540mm
								Weight	17kg

Camira Xtreme Plus Havana

Price	£	€	\$	Lead time	Quick ship (2-3 weeks)
	£363	€418	\$509		



Product Code: OFFICEFAB

Description: Black, fully upholstered task chair with sliding seat. Adjustable back & arms and self-adjusting & lockable single synchronised mechanism as standard

Price	£	€	\$	Price	£	€	\$	Dimensions	
Group 0	£353	€406	\$495	Group 4	£402	€463	\$563	Height	1,000-1,120mm
Group 1	£363	€418	\$509	Group 5	£419	€482	\$587	Width	545mm
Group 2	£377	€434	\$528	Group 6	£472	€543	\$661	Depth	400-450mm
Group 3	£388	€447	\$544	Group 7	£507	€584	\$710	Seat Height	420-540mm
								Weight	17kg

Camira Xtreme Plus Havana

Price	£	€	\$	Lead time	Quick ship (2-3 weeks)
	£363	€418	\$509		



Product Code: MCM/MESH/CHR

Description: Mesh back cantilever chair with chrome base and black polypropylene shell & arms

Price	£	€	\$	Price	£	€	\$	Dimensions	
Group 0	£339	€390	\$475	Group 4	£376	€433	\$527	Height	880mm
Group 1	£347	€391	\$486	Group 5	£389	€448	\$545	Width	535mm
Group 2	£357	€411	\$500	Group 6	£428	€493	\$600	Depth	620mm
Group 3	£365	€420	\$511	Group 7	£454	€523	\$636	Seat Height	475mm
								Weight	10kg



Gravity

Light work chair with mesh upholstery

Task Chairs

Gravity

Product Code: OGR4

Description: Elegant, lightweight work chair with black mesh upholstery & rocking mechanism. Quick Ship available in black only

Price	£	€	\$
	£400	€460	\$560

Lead time	Quick ship (2-3 weeks)
------------------	---------------------------

Dimensions

Height	950-1080mm
Width	580mm
Depth	620mm
Seat Height	460-600mm
Seat Depth	460mm
Weight	9kg



Product Code: OGR2

Description: Elegant, lightweight work chair with polished aluminium base, light grey mesh & rocking mechanism

Price	£	€	\$
	£450	€518	\$630

Dimensions

Height	950-1080mm
Width	580mm
Depth	620mm
Seat Height	460-600mm
Seat Depth	460mm
Weight	9kg



Is

My



Product Code: MIS2I
Description: Stacking chair with upholstered seat, moulded back, metal 4 leg base & black feet. Stacks to 4 high. Options include casters (upgrade cost applies). Available with a chrome effect or black metal base
Certification: BS EN 15373: 2007

Price	£	€	\$	Price	£	€	\$	Dimensions	
Group 0	£228	€252	\$307	Group 5	£309	€342	\$416	Height	820mm
Group 1	£233	€258	\$314	Group 6	£388	€429	\$523	Width	505mm
Group 2	£242	€268	\$327	Group 7	£420	€465	\$566	Depth	535mm
Group 3	£282	€312	\$380					Seat Height	480mm
Group 4	£291	€322	\$392					Weight	9kg



Product Code: MISSI
Description: Stacking chair, fully upholstered with metal 4 leg base & black feet. Stacks to 4 high. Options include casters (upgrade cost applies). Available with a chrome effect or black metal base.
Certification: BS EN 15373: 2007

Price	£	€	\$	Price	£	€	\$	Dimensions	
Group 0	£258	€286	\$348	Group 5	£393	€435	\$530	Height	820mm
Group 1	£264	€293	\$356	Group 6	£483	€534	\$650	Width	505mm
Group 2	£271	€301	\$366	Group 7	£523	€579	\$705	Depth	535mm
Group 3	£353	€390	\$475					Seat Height	480mm
Group 4	£368	€408	\$496					Weight	9kg



Product Code: MIS2A
Description: Stacking armchair with upholstered seat, moulded back, metal 4 leg base & black feet. Stacks to 4 high. Options include casters and a writing tablet (upgrade costs apply). Available with a chrome effect or black metal base
Certification: BS EN 15373: 2007

Price	£	€	\$	Price	£	€	\$	Dimensions	
Group 0	£264	€293	\$356	Group 5	£334	€370	\$450	Height	820mm
Group 1	£268	€297	\$362	Group 6	£413	€457	\$556	Width	590mm
Group 2	£291	€322	\$392	Group 7	£445	€493	\$600	Depth	535mm
Group 3	£308	€341	\$415					Seat Height	480mm
Group 4	£315	€349	\$425					Weight	10kg



Product Code: MISSA
Description: Stacking armchair, fully upholstered with metal 4 leg base & black feet. Stacks to 4 high. Options include casters and a writing tablet (upgrade costs apply). Available with a chrome effect or black metal base
Certification: BS EN 15373: 2007

Price	£	€	\$	Price	£	€	\$	Dimensions	
Group 0	£315	€349	\$425	Group 5	£418	€463	\$563	Height	820mm
Group 1	£322	€357	\$434	Group 6	£509	€563	\$685	Width	590mm
Group 2	£356	€394	\$479	Group 7	£548	€607	\$738	Depth	535mm
Group 3	£379	€419	\$510					Seat Height	480mm
Group 4	£393	€435	\$530					Weight	10kg

Price	£	€	\$
Linking device	+£28	+€32	+\$38
Casters	+£42	+€47	+\$57
White 8mm laminate writing table	+£107	+€119	+\$145

Metal Finishes



Fabrics



See pg 233

Metal Finishes



Fabrics



See pg 233



Product Code: MMYIA
Description: Fully upholstered stacking meeting chair with silver or white cantilever base. Stacks to 4 high
Certification: BS EN 15373: 2007

Price	£	€	\$	Price	£	€	\$	Dimensions	
Group 0	£262	€302	\$367	Group 6	£449	€517	\$629	Height	840mm
Group 1	£279	€321	\$391	Group 7	£504	€580	\$706	Width	560mm
Group 2	£301	€347	\$422	Leather 1	£413	€475	\$579	Depth	580mm
Group 3	£317	€365	\$444	Leather 2	£480	€552	\$672	Seat Height	460mm
Group 4	£339	€390	\$475	Leather 3	£546	€628	\$765	Weight	10kg
Group 5	£367	€423	\$514						



Product Code: MRP2A

Description: A universal training room chair with a black plastic back & seat and writing tablet with cup holder on a dark grey 360 swivel base

Price	£	€	\$
	£370	€426	\$518

Lead time Quick ship
(2-3 weeks)

Dimensions	
Height	900mm
Width	640mm
Depth	590mm
Seat Height	445mm
Seat Depth	440mm
Weight	14kg



Product Code: MRP2B

Description: A universal training room chair with a black plastic back, upholstered seat and writing tablet with cup holder on a dark grey 360 swivel base

Price	£	€	\$
Group 0	£409	€471	\$573
Group 1	£420	€483	\$588
Group 2	£434	€500	\$608
Group 3	£444	€511	\$622

Price	£	€	\$
Group 4	£458	€527	\$642
Group 5	£476	€548	\$667
Group 6	£528	€608	\$740
Group 7	£563	€648	\$789

Dimensions	
Height	900mm
Width	640mm
Depth	590mm
Seat Height	445mm
Seat Depth	440mm
Weight	14kg



Fabrics



See pg 233

Hive Modular Specifications Understanding the Components

When ordering your Hive layout, please supply drawings of your configuration and use the part descriptions as below. You only need to specify the colour/finish of the workrails and legs; Connection will calculate the quantity and sizes needed for your layout.

- 1 Internal bench
- 2 Pyramid back
- 3 Workrail
- 4 Top screen
- 5 Foot
- 6 External bench

- 1 Bench
- 2 Flat back
- 3 Top screen
- 4 Workrail

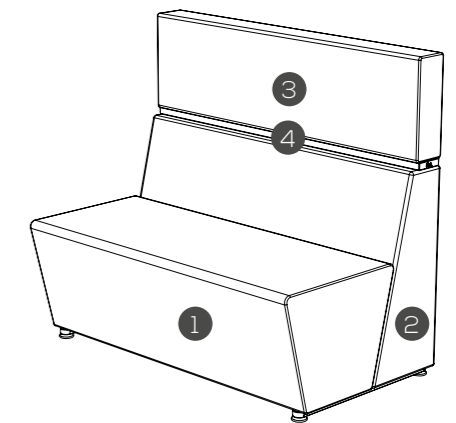
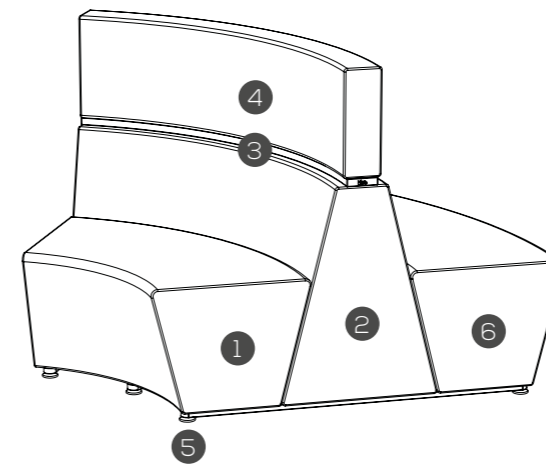

- 1 Bench
- 2 Single sided back
- 3 Workrail
- 4 Leg
- 5 Bottom screen
- 6 Top screen

- 1 Internal bench
- 2 Double sided back
- 3 External bench
- 4 Leg
- 5 Top screen
- 6 Workrail

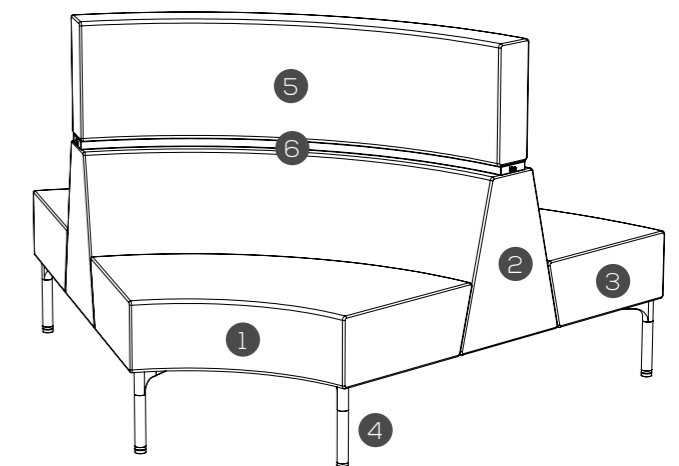

When ordering power and/or data for your Hive configuration, please see the example diagram below which details the positions at which this can be placed on an individual unit. There is no limit on the number of positions that can be taken on one unit.

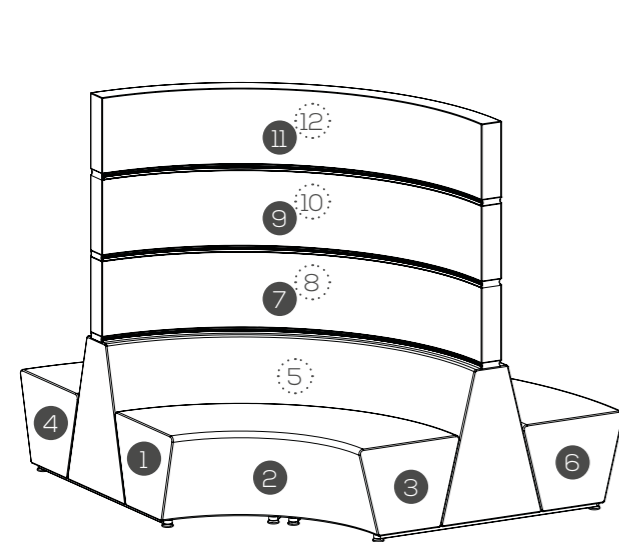

Hive Power Module Positions

1	Inner bench left
2	Inner bench centre
3	Inner bench right
4	Outer bench left
5	Outer bench centre
6	Outer bench right
7	Centre inner first screen
8	Centre outer first screen
9	Centre inner second screen
10	Centre outer second screen
11	Centre inner third screen
12	Centre outer third screen

The numbering on the diagram is based on looking at the unit from the front facing internal side.

The numbers with dotted lines indicate positions that are not visible from the front internal side.

The diagram shows a curved section with both internal and external benches, three screens high.

The same numbering system can be used on any Hive configuration.

When ordering power options on Hive, please use the numbering system to describe the fitted position of your chosen power modules.

Product Code: SHF1E
800mm back, bench

Price	£	€	\$
Group 3	£1,426	€1,577	\$1,920
Group 4	£1,470	€1,625	\$1,979
Group 5	£1,557	€1,722	\$2,096
Group 6	£1,933	€2,138	\$2,603

Dimensions

Height	713mm
Width	800mm
Depth	720mm
Weight	22kg

Product Code: SHF2E
1,200mm back, bench

Price	£	€	\$
Group 3	£1,805	€1,997	\$2,431
Group 4	£1,870	€2,068	\$2,518
Group 5	£2,002	€2,214	\$2,695
Group 6	£2,560	€2,832	\$3,447

Dimensions

Height	713mm
Width	1,200mm
Depth	720mm
Weight	33kg

Product Code: SHF3E
1,600mm back, bench

Price	£	€	\$
Group 3	£2,262	€2,502	\$3,045
Group 4	£2,348	€2,597	\$3,162
Group 5	£2,523	€2,790	\$3,397
Group 6	£3,262	€3,608	\$4,392

Dimensions

Height	713mm
Width	1,600mm
Depth	720mm
Weight	37kg

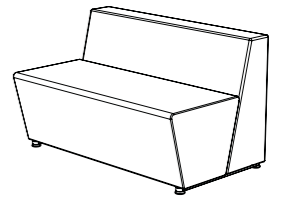

Product Code: SHF1F
800mm back, bench, 1 screen

Price	£	€	\$
Group 3	£1,864	€2,061	\$2,509
Group 4	£1,919	€2,122	\$2,583
Group 5	£2,031	€2,246	\$2,735
Group 6	£2,508	€2,774	\$3,377

Dimensions

Height	1,078mm
Width	800mm
Depth	720mm
Weight	36kg

Product Code: SHF2F
1,200mm back, bench, 1 screen

Price	£	€	\$
Group 3	£2,270	€2,511	\$3,057
Group 4	£2,355	€2,604	\$3,170
Group 5	£2,522	€2,789	\$3,395
Group 6	£3,232	€3,575	\$4,352

Dimensions

Height	1,078mm
Width	1,200mm
Depth	720mm
Weight	42kg

Product Code: SHF3F
1,600mm back, bench, 1 screen

Price	£	€	\$
Group 3	£2,865	€3,169	\$3,857
Group 4	£2,976	€3,292	\$4,007
Group 5	£3,198	€3,537	\$4,305
Group 6	£4,140	€4,579	\$5,574

Dimensions

Height	1,078mm
Width	1,600mm
Depth	720mm
Weight	53kg

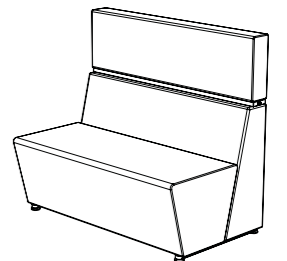

Product Code: SHF1G
800mm back, bench, 2 screens

Price	£	€	\$
Group 3	£2,304	€2,548	\$3,101
Group 4	£2,370	€2,621	\$3,191
Group 5	£2,506	€2,772	\$3,374
Group 6	£3,085	€3,411	\$4,153

Dimensions

Height	1,443mm
Width	800mm
Depth	720mm
Weight	42kg

Product Code: SHF2G
1,200mm back, bench, 2 screens

Price	£	€	\$
Group 3	£2,738	€3,028	\$3,687
Group 4	£2,838	€3,139	\$3,821
Group 5	£3,043	€3,365	\$4,097
Group 6	£3,905	€4,319	\$5,257

Dimensions

Height	1,443mm
Width	1,200mm
Depth	720mm
Weight	47kg

Product Code: SHF3G
1,600mm back, bench, 2 screens

Price	£	€	\$
Group 3	£3,468	€3,836	\$4,669
Group 4	£3,603	€3,984	\$4,850
Group 5	£3,873	€4,283	\$5,214
Group 6	£5,017	€5,548	\$6,754

Dimensions

Height	1,443mm
Width	1,600mm
Depth	720mm
Weight	64kg

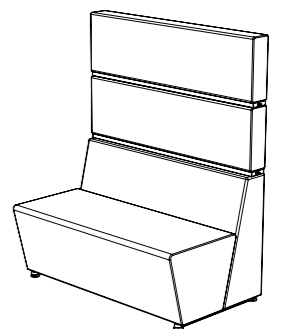

Hive Modular Specifications Back-to-Back Straight Modules

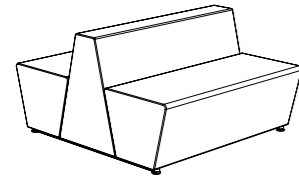

Product Code: SHV5L
800mm back, 2 benches

Price	£	€	\$
Group 3	£1,870	€2,068	\$2,518
Group 4	£1,931	€2,136	\$2,600
Group 5	£2,055	€2,273	\$2,767
Group 6	£2,576	€2,849	\$3,468

Dimensions

Height	713mm
Width	800mm
Depth	1,316mm
Weight	36kg

Product Code: SHV1L
1,200mm back, 2 benches

Price	£	€	\$
Group 3	£2,479	€2,742	\$3,338
Group 4	£2,570	€2,842	\$3,460
Group 5	£2,751	€3,042	\$3,703
Group 6	£3,526	€3,899	\$4,746

Dimensions

Height	713mm
Width	1,200mm
Depth	1,316mm
Weight	47kg

Product Code: SHV6L
1,600mm back, 2 benches

Price	£	€	\$
Group 3	£3,067	€3,392	\$4,129
Group 4	£3,188	€3,525	\$4,291
Group 5	£3,428	€3,791	\$4,615
Group 6	£4,450	€4,921	\$5,991

Dimensions

Height	713mm
Width	1,600mm
Depth	1,316mm
Weight	52kg

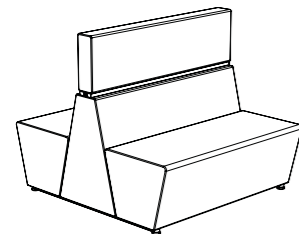

Product Code: SHV5M
800mm back, 2 benches, 1 screen

Price	£	€	\$
Group 3	£2,288	€2,530	\$3,080
Group 4	£2,362	€2,612	\$3,180
Group 5	£2,506	€2,772	\$3,374
Group 6	£3,126	€3,457	\$4,209

Dimensions

Height	1,078mm
Width	800mm
Depth	1,316mm
Weight	56kg

Product Code: SHV1M
1,200mm back, 2 benches, 1 screen

Price	£	€	\$
Group 3	£2,922	€3,232	\$3,934
Group 4	£3,031	€3,352	\$4,080
Group 5	£3,247	€3,591	\$4,371
Group 6	£4,165	€4,606	\$5,607

Dimensions

Height	1,078mm
Width	1,200mm
Depth	1,316mm
Weight	63kg

Product Code: SHV6M
1,600mm back, 2 benches, 1 screen

Price	£	€	\$
Group 3	£3,642	€4,028	\$4,903
Group 4	£3,786	€4,186	\$5,096
Group 5	£4,072	€4,503	\$5,481
Group 6	£5,287	€5,847	\$7,118

Dimensions

Height	1,078mm
Width	1,600mm
Depth	1,316mm
Weight	68kg

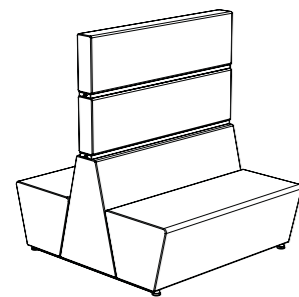

Product Code: SHV5N
800mm back, 2 benches, 2 screens

Price	£	€	\$
Group 3	£2,706	€2,993	\$3,643
Group 4	£2,790	€3,086	\$3,757
Group 5	£2,959	€3,272	\$3,983
Group 6	£3,674	€4,063	\$4,947

Dimensions

Height	1,443mm
Width	800mm
Depth	1,316mm
Weight	64kg

Product Code: SHV1N
1,200mm back, 2 benches, 2 screens

Price	£	€	\$
Group 3	£3,368	€3,724	\$4,534
Group 4	£3,491	€3,861	\$4,700
Group 5	£3,742	€4,138	\$5,038
Group 6	£4,807	€5,316	\$6,471

Dimensions

Height	1,443mm
Width	1,200mm
Depth	1,316mm
Weight	71kg

Product Code: SHV6N
1,600mm back, 2 benches, 2 screens

Price	£	€	\$
Group 3	£4,217	€4,664	\$5,677
Group 4	£4,383	€4,847	\$5,900
Group 5	£4,713	€5,212	\$6,345
Group 6	£6,122	€6,771	\$8,242

Dimensions

Height	1,443mm
Width	1,600mm
Depth	1,316mm
Weight	77kg

Hive Modular Specifications Curved Modules, External Bench

Product Code: SHV2G
Description: 60° back, external bench

Price	£	€	\$
Group 3	£2,479	€2,742	\$3,338
Group 4	£2,581	€2,855	\$3,475
Group 5	£2,786	€3,081	\$3,751
Group 6	£3,655	€4,042	\$4,920

Dimensions

Height	713mm
Width	1,904mm
Depth	910mm
Weight	48kg

Product Code: SHV3G*
Description: 90° back, external bench

Price	£	€	\$
Group 3	£3,103	€3,432	\$4,178
Group 4	£3,204	€3,544	\$4,314
Group 5	£3,410	€3,771	\$4,591
Group 6	£4,276	€4,729	\$5,757

Dimensions

Height	713mm
Width	2,692mm
Depth	910mm
Weight	52kg

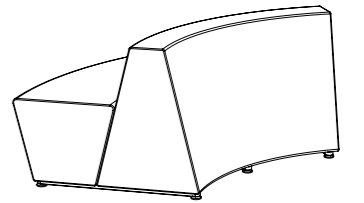

Product Code: SHV2I
Description: 60° back, external bench, 1 screen

Price	£	€	\$
Group 3	£2,995	€3,312	\$4,032
Group 4	£3,114	€3,444	\$4,192
Group 5	£3,353	€3,708	\$4,514
Group 6	£4,366	€4,828	\$5,878

Dimensions

Height	1,078mm
Width	1,904mm
Depth	910mm
Weight	61kg

Product Code: SHV3I*
Description: 90° back, external bench, 1 screen

Price	£	€	\$
Group 3	£3,763	€4,161	\$5,066
Group 4	£3,894	€4,306	\$5,242
Group 5	£4,155	€4,595	\$5,593
Group 6	£5,262	€5,819	\$7,084

Dimensions

Height	1,078mm
Width	2,692mm
Depth	910mm
Weight	64kg

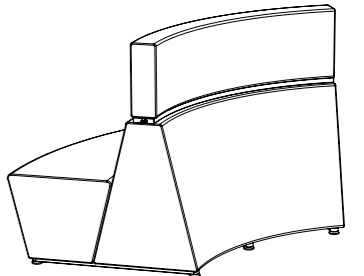

Product Code: SHV2K
Description: 60° back, external bench, 2 screens

Price	£	€	\$
Group 3	£3,510	€3,882	\$4,725
Group 4	£3,646	€4,032	\$4,909
Group 5	£3,919	€4,334	\$5,276
Group 6	£5,078	€5,616	\$6,837

Dimensions

Height	1,443mm
Width	1,904mm
Depth	910mm
Weight	69kg

Product Code: SHV3K*
Description: 90° back, external bench, 2 screens

Price	£	€	\$
Group 3	£4,422	€4,890	\$5,953
Group 4	£4,581	€5,066	\$6,167
Group 5	£4,899	€5,418	\$6,596
Group 6	£6,249	€6,911	\$8,413

Dimensions

Height	1,443mm
Width	2,692mm
Depth	910mm
Weight	84kg

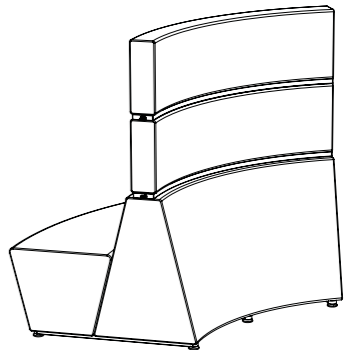

Product Code: SHV2T
Description: 60° back, external bench, 3 screens

Price	£	€	\$
Group 3	£5,462	€6,040	\$7,353
Group 4	£5,598	€6,191	\$7,537
Group 5	£5,870	€6,491	\$7,902
Group 6	£7,028	€7,772	\$9,462

Dimensions

Height	1,808mm
Width	1,904mm
Depth	910mm
Weight	90kg

Product Code: SHV3T*
Description: 90° back, external bench, 3 screens

Price	£	€	\$
Group 3	£5,988	€6,622	\$8,062
Group 4	£6,150	€6,800	\$8,279
Group 5	£6,472	€7,157	\$8,713
Group 6	£7,844	€8,674	\$10,559

Dimensions

Height	1,808mm
Width	2,692mm
Depth	910mm
Weight	92kg

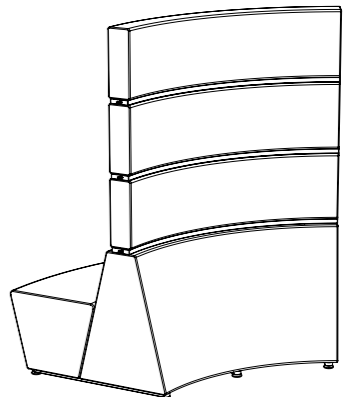

*On all 90° curved modules the external bench is in 2 pieces
Please note: On curved modules measurements are taken across the widest point

Hive Modular Specifications Curved Modules, Internal Bench

Hive Modular Specifications Back-to-Back Curved Modules

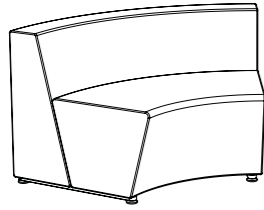

Product Code: SHF10E
Description: 60° back, internal bench

Price	£	€	\$
Group 3	£2,314	€2,559	\$3,115
Group 4	£2,383	€2,635	\$3,208
Group 5	£2,519	€2,786	\$3,391
Group 6	£3,098	€3,426	\$4,171

Dimensions	
Height	713mm
Width	1,200mm
Depth	720mm
Weight	29kg

Product Code: SHF9E
Description: 90° back, internal bench

Price	£	€	\$
Group 3	£2,787	€3,082	\$3,752
Group 4	£2,878	€3,183	\$3,874
Group 5	£3,060	€3,384	\$4,119
Group 6	£3,831	€4,237	\$5,158

Dimensions	
Height	713mm
Width	1,850mm
Depth	720mm
Weight	44kg

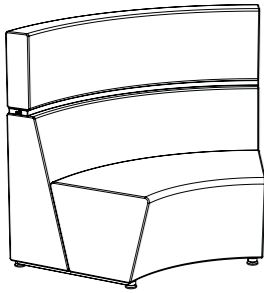

Product Code: SHF10F
Description: 60° back, internal bench, 1 screen

Price	£	€	\$
Group 3	£3,150	€3,484	\$4,241
Group 4	£3,264	€3,609	\$4,394
Group 5	£3,490	€3,860	\$4,699
Group 6	£4,455	€4,927	\$5,998

Dimensions	
Height	1,078mm
Width	1,200mm
Depth	720mm
Weight	50kg

Product Code: SHF9F
Description: 90° back, internal bench, 1 screen

Price	£	€	\$
Group 3	£3,645	€4,031	\$4,907
Group 4	£3,771	€4,170	\$5,077
Group 5	£4,024	€4,450	\$5,417
Group 6	£5,096	€5,635	\$6,860

Dimensions	
Height	1,078mm
Width	1,850mm
Depth	720mm
Weight	72kg

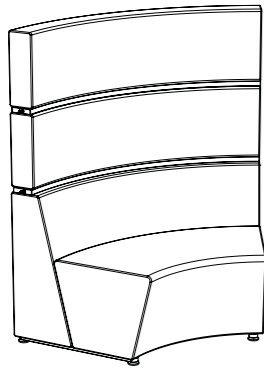

Product Code: SHF10G
Description: 60° back, internal bench, 2 screens

Price	£	€	\$
Group 3	£3,606	€3,988	\$4,854
Group 4	£3,719	€4,113	\$5,007
Group 5	£3,946	€4,364	\$5,312
Group 6	£4,911	€5,431	\$6,611

Dimensions	
Height	1,443mm
Width	1,200mm
Depth	720mm
Weight	58kg

Product Code: SHF9G
Description: 90° back, internal bench, 2 screens

Price	£	€	\$
Group 3	£4,215	€4,661	\$5,675
Group 4	£4,341	€4,801	\$5,844
Group 5	£4,594	€5,080	\$6,184
Group 6	£5,666	€6,266	\$7,628

Dimensions	
Height	1,443mm
Width	1,850mm
Depth	720mm
Weight	87kg

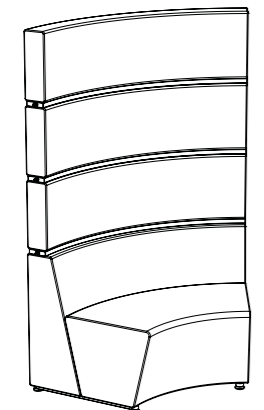

Product Code: SHF10H
Description: 60° back, internal bench, 3 screens

Price	£	€	\$
Group 3	£4,419	€4,887	\$5,949
Group 4	£4,578	€5,063	\$6,163
Group 5	£4,896	€5,415	\$6,592
Group 6	£6,246	€6,907	\$8,409

Dimensions	
Height	1,808mm
Width	1,200mm
Depth	720mm
Weight	70kg

Product Code: SHF9H
Description: 90° back, internal bench, 3 screens

Price	£	€	\$
Group 3	£5,108	€5,649	\$6,877
Group 4	£5,271	€5,829	\$7,096
Group 5	£5,593	€6,185	\$7,530
Group 6	£6,964	€7,701	\$9,375

Dimensions	
Height	1,808mm
Width	1,850mm
Depth	720mm
Weight	105kg

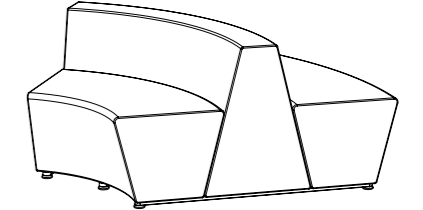

Product Code: SHV2L
Description: 60° back, 2 benches

Price	£	€	\$
Group 3	£3,278	€3,625	\$4,413
Group 4	£3,406	€3,767	\$4,585
Group 5	£3,666	€4,054	\$4,935
Group 6	£4,766	€5,271	\$6,417

Dimensions	
Height	713mm
Width	1,904mm
Depth	1,316mm

Product Code: SHV3L*
Description: 90° back, 2 benches

Price	£	€	\$
Group 3	£4,034	€4,461	\$5,431
Group 4	£4,169	€4,611	\$5,613
Group 5	£4,443	€4,913	\$5,981
Group 6	£5,600	€6,193	\$7,539

Dimensions	
Height	713mm
Width	2,692mm
Depth	1,316mm

Product Code: SHV2M
Description: 60° back, 2 benches, 1 screen

Price	£	€	\$
Group 3	£3,793	€4,195	\$5,106
Group 4	£3,940	€4,357	\$5,304
Group 5	£4,233	€4,681	\$5,698
Group 6	£5,478	€6,058	\$7,374

Dimensions	
Height	1,078mm
Width	1,904mm
Depth	1,316mm

Product Code: SHV3M*
Description: 90° back, 2 benches, 1 screen

Price	£	€	\$
Group 3	£4,694	€5,190	\$6,319
Group 4	£4,859	€5,373	\$6,541
Group 5	£5,188	€5,737	\$6,984
Group 6	£6,585	€7,282	\$8,865

Dimensions	
Height	1,078mm
Width	2,692mm
Depth	1,316mm

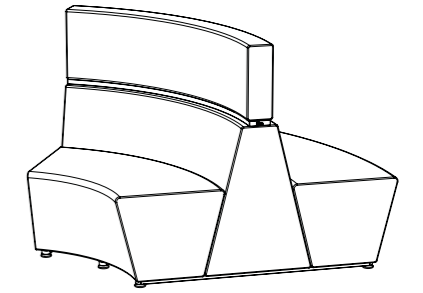

Product Code: SHV2N
Description: 60° back, 2 benches, 2 screens

Price	£	€	\$
Group 3	£4,309	€4,765	\$5,801
Group 4	£4,472	€4,945	\$6,020
Group 5	£4,799	€5,307	\$6,460
Group 6	£6,190	€6,845	\$8,333

Dimensions	
Height	1,443mm
Width	1,904mm
Depth	1,316mm

Product Code: SHV3N*
Description: 90° back, 2 benches, 2 screens

Price	£	€	\$
Group 3	£5,354	€5,921	\$7,208
Group 4	£5,546	€6,133	\$7,467
Group 5	£5,932	€6,560	\$7,986
Group 6	£7,571	€8,372	\$10,192

Dimensions	
Height	1,443mm
Width	2,692mm
Depth	1,316mm

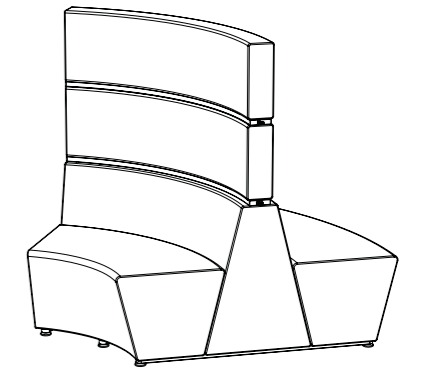

Product Code: SHV2V
Description: 60° back, 2 benches, 3 screens

Price	£	€	\$
Group 3	£6,322	€6,991	\$8,511
Group 4	£6,481	€7,167	\$8,725
Group 5	£6,800	€7,519	\$9,154
Group 6	£8,152	€9,014	\$10,974

Dimensions	
Height	1,808mm
Width	1,904mm
Depth	1,316mm

Product Code: SHV3V*
Description: 90° back, 2 benches, 3 screens

Price	£	€	\$
Group 3	£7,259	€8,027	\$9,772
Group 4	£7,469	€8,260	\$10,055
Group 5	£7,889	€8,724	\$10,621
Group 6	£9,675	€10,699	\$13,025

Dimensions	
Height	1,808mm
Width	2,692mm
Depth	1,316mm

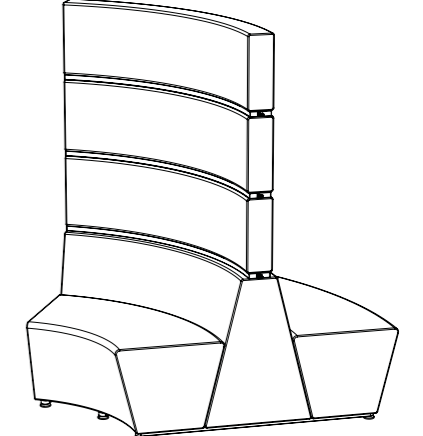

Please note: On curved modules measurements are taken across the widest point

*On all 90° curved modules the external bench is in 2 pieces
Please note: On curved modules measurements are taken across the widest point

Hive Modular Specifications Corner Modules

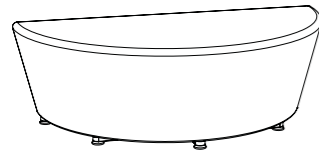

Product Code: SHV8
Description: D-end bench

Price	£	€	\$	Dimensions
Group 3	£1,121	€1,240	\$1,510	Height 433mm
Group 4	£1,167	€1,291	\$1,571	Width 1,316mm
Group 5	£1,257	€1,391	\$1,693	Depth 660mm
Group 6	£1,643	€1,817	\$2,212	

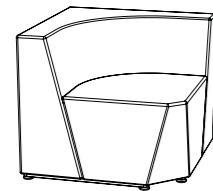

Product Code: SHF4E
Description: Corner back, bench

Price	£	€	\$	Dimensions
Group 3	£2,233	€2,470	\$3,006	Height 713mm
Group 4	£2,309	€2,553	\$3,108	Width 800mm
Group 5	£2,461	€2,721	\$3,313	Depth 800mm
Group 6	£3,110	€3,439	\$4,186	

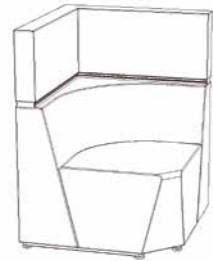

Product Code: SHF4F
Description: Corner back, bench, 1 corner screen

Price	£	€	\$	Dimensions
Group 3	£2,773	€3,066	\$3,733	Height 1,078mm
Group 4	£2,867	€3,171	\$3,860	Width 800mm
Group 5	£3,056	€3,379	\$4,114	Depth 800mm
Group 6	£3,857	€4,266	\$5,193	

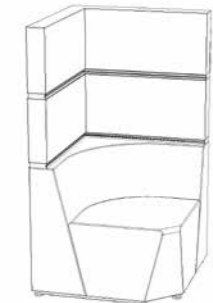

Product Code: SHF4G
Description: Corner back, bench, 2 corner screens

Price	£	€	\$	Dimensions
Group 3	£3,314	€3,666	\$4,462	Height 1,443mm
Group 4	£3,427	€3,790	\$4,613	Width 800mm
Group 5	£3,651	€4,038	\$4,916	Depth 800mm
Group 6	£4,605	€5,093	\$6,200	

Hive Modular Specifications T-Modules

Product Code: SHF6M
Description: T-back, benches

Price	£	€	\$	Dimensions
Group 3	£3,404	€3,764	\$4,583	Height 713mm
Group 4	£3,593	€3,974	\$4,837	Width 1,476mm
Group 5	£3,802	€4,205	\$5,119	Depth 800mm
Group 6	£4,695	€5,192	\$6,320	

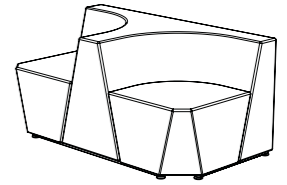

Product Code: SHF6N
Description: T-back, benches, 1 T-screen

Price	£	€	\$	Dimensions
Group 3	£4,327	€4,786	\$5,826	Height 1,078mm
Group 4	£4,543	€5,024	\$6,116	Width 1,476mm
Group 5	£4,811	€5,320	\$6,477	Depth 800mm
Group 6	£5,947	€6,576	\$8,006	

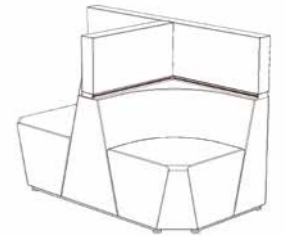

Product Code: SHF6O
Description: T-back, benches, 2 T-screens

Price	£	€	\$	Dimensions
Group 3	£5,249	€5,805	\$7,066	Height 1,443mm
Group 4	£5,495	€6,077	\$7,398	Width 1,476mm
Group 5	£5,819	€6,435	\$7,833	Depth 800mm
Group 6	£7,198	€7,960	\$9,690	



Hive Modular Specifications Media Screen Modules

Hive Modular Specifications Work Surfaces



Product Code: SHVIP
Description: 1,200mm media screen

Price	£	€	\$	Dimensions
Group 3	£2,024	€2,238	\$2,725	Height 1,443mm
Group 4	£2,091	€2,313	\$2,816	Width 1,200mm
Group 5	£2,228	€2,464	\$2,999	Depth 500mm
Group 6	£2,807	€3,104	\$3,779	

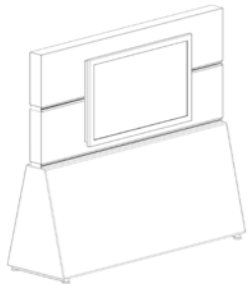

Product Code: SHV6P
Description: 1,600mm media screen

Price	£	€	\$	Dimensions
Group 3	£2,419	€2,675	\$3,257	Height 1,443mm
Group 4	£2,498	€2,763	\$3,363	Width 1,600mm
Group 5	£2,657	€2,939	\$3,577	Depth 500mm
Group 6	£3,333	€3,686	\$4,487	

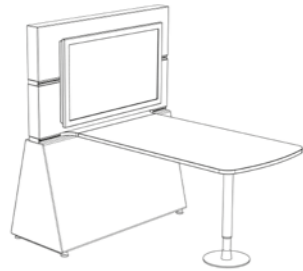

Product Options

TV Mounting Bracket	£78	€87	\$105
Cantilever Work Surface	See next page		

Product Code: THV3
Description: Cantilever low work surface with white or natura column & base

Price (Table Only)	£	€	\$	Dimensions
	£900	€995	\$1,211	Height 713mm
				Width 750mm
				Depth 1,500mm

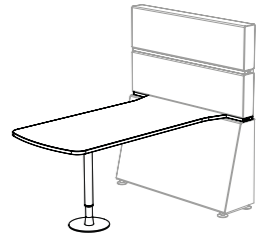

Product Code: THV11
Description: Cantilever high work surface with white or natura column & base

Price (Table Only)	£	€	\$	Dimensions
	£900	€995	\$1,211	Height 1,073mm
				Width 750mm
				Depth 1,500mm

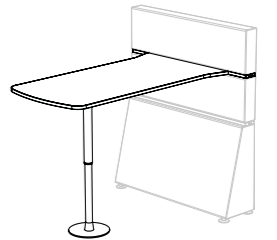

Product Code: THV22
Description: Pod work surface with no arm & white or natura column & base for 60° or 90° curved modules

Price (Table Only)	£	€	\$	Dimensions
	£955	€1,056	\$1,286	Height 713mm
				Width 900mm
				Depth 1,650mm



Product Code: THV16
Description: Cantilever high work surface with white or natura column & base

Price (Table Only)	£	€	\$	Dimensions
	£918	€1,019	\$1,240	Height 713mm
				Width 900mm
				Depth 1,200mm



Hive Modular Specifications Booth Work Surfaces

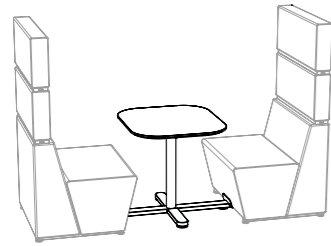

Product Code: THV13
Description: Integrated table for 800mm modules with white or natura column & base

Price (Table Only)	£	€	\$	Dimensions
	£709	€785	\$955	Height 713mm
				Width 800mm
				Depth 700mm

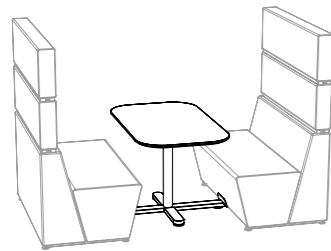

Product Code: THV14
Description: Integrated table for 1,200mm modules with white or natura column & base

Price (Table Only)	£	€	\$	Dimensions
	£729	€807	\$982	Height 713mm
				Width 1,200mm
				Depth 700mm

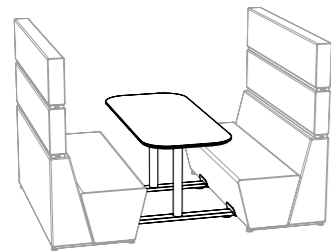

Product Code: THV15
Description: Integrated table for 1,600mm modules with white or natura column & base

Price (Table Only)	£	€	\$	Dimensions
	£1,046	€1,157	\$1,409	Height 713mm
				Width 1,600mm
				Depth 700mm

Hive Modular Specifications Straight Modules

Product Code: SHL1A
 800mm back, bench, legs

Price	£	€	\$
Group 3	£1,239	€1,370	\$1,668
Group 4	£1,269	€1,403	\$1,708
Group 5	£1,325	€1,466	\$1,784
Group 6	£1,569	€1,736	\$2,113

Dimensions	
Height	713mm
Width	800mm
Depth	720mm

Product Code: SHL2A
 1,200mm back, bench, legs

Price	£	€	\$
Group 3	£1,631	€1,804	\$2,196
Group 4	£1,666	€1,843	\$2,243
Group 5	£1,736	€1,920	\$2,337
Group 6	£2,033	€2,249	\$2,737

Dimensions	
Height	713mm
Width	1,200mm
Depth	720mm

Product Code: SHL3A
 1,600mm back, bench, legs

Price	£	€	\$
Group 3	£1,766	€1,953	\$2,378
Group 4	£1,811	€2,003	\$2,438
Group 5	£1,903	€2,105	\$2,562
Group 6	£2,290	€2,533	\$3,083

Dimensions	
Height	713mm
Width	1,600mm
Depth	720mm

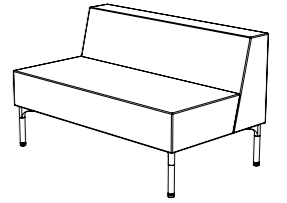

Product Code: SHL1B
 800mm back, bench, 1 screen, legs

Price	£	€	\$
Group 3	£1,698	€1,878	\$2,287
Group 4	£1,740	€1,924	\$2,343
Group 5	£1,823	€2,016	\$2,455
Group 6	£2,174	€2,404	\$2,926

Dimensions	
Height	1,078mm
Width	800mm
Depth	720mm

Product Code: SHL2B
 1,200mm back, bench, 1 screen, legs

Price	£	€	\$
Group 3	£2,118	€2,343	\$2,852
Group 4	£2,173	€2,403	\$2,925
Group 5	£2,281	€2,522	\$3,071
Group 6	£2,737	€3,027	\$3,685

Dimensions	
Height	1,078mm
Width	1,200mm
Depth	720mm

Product Code: SHL3B
 1,600mm back, bench, 1 screen, legs

Price	£	€	\$
Group 3	£2,455	€2,716	\$3,306
Group 4	£2,525	€2,793	\$3,400
Group 5	£2,667	€2,949	\$3,590
Group 6	£3,266	€3,611	\$4,396

Dimensions	
Height	1,078mm
Width	1,600mm
Depth	720mm

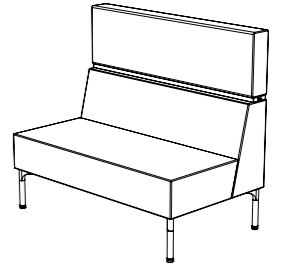

Product Code: SHL1C
 800mm back, bench, 2 screens, legs

Price	£	€	\$
Group 3	£2,271	€2,512	\$3,058
Group 4	£2,325	€2,572	\$3,131
Group 5	£2,434	€2,691	\$3,276
Group 6	£2,890	€3,196	\$3,891

Dimensions	
Height	1,443mm
Width	800mm
Depth	720mm

Product Code: SHL2C
 1,200mm back, bench, 2 screens, legs

Price	£	€	\$
Group 3	£2,607	€2,884	\$3,510
Group 4	£2,680	€2,964	\$3,608
Group 5	£2,825	€3,124	\$3,803
Group 6	£3,442	€3,807	\$4,634

Dimensions	
Height	1,443mm
Width	1,200mm
Depth	720mm

Product Code: SHL3C
 1,600mm back, bench, 2 screens, legs

Price	£	€	\$
Group 3	£3,087	€3,414	\$4,156
Group 4	£3,183	€3,521	\$4,286
Group 5	£3,374	€3,731	\$4,542
Group 6	£4,186	€4,629	\$5,635

Dimensions	
Height	1,443mm
Width	1,600mm
Depth	720mm

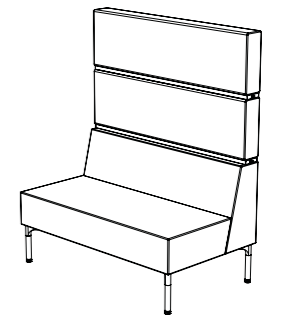

Hive Modular Specifications Back-to-Back Straight Modules

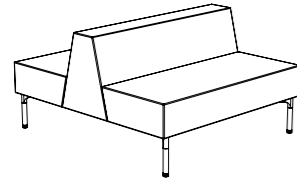

Product Code: SHL4A
800mm back, 2 benches, legs

Price	£	€	\$
Group 3	£1,920	€2,123	\$2,585
Group 4	£1,965	€2,173	\$2,645
Group 5	£2,053	€2,271	\$2,764
Group 6	£2,430	€2,688	\$3,272

Dimensions			
Height		713mm	
Width		800mm	
Depth		1,316mm	

Product Code: SHL5A
1,200mm back, 2 benches, legs

Price	£	€	\$
Group 3	£2,404	€2,659	\$3,237
Group 4	£2,456	€2,717	\$3,307
Group 5	£2,560	€2,832	\$3,447
Group 6	£3,000	€3,318	\$4,039

Dimensions			
Height		713mm	
Width		1,200mm	
Depth		1,316mm	

Product Code: SHL6A
1,600mm back, 2 benches, legs

Price	£	€	\$
Group 3	£2,633	€2,912	\$3,545
Group 4	£2,702	€2,988	\$3,638
Group 5	£2,837	€3,138	\$3,820
Group 6	£3,417	€3,779	\$4,601

Dimensions			
Height		713mm	
Width		1,600mm	
Depth		1,316mm	

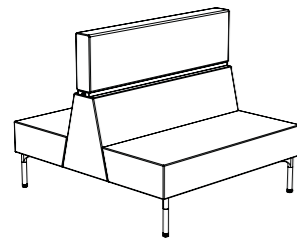

Product Code: SHL4B
800mm back, 2 benches, 1 screen, legs

Price	£	€	\$
Group 3	£2,380	€2,632	\$3,204
Group 4	£2,437	€2,695	\$3,281
Group 5	£2,550	€2,820	\$3,433
Group 6	£3,034	€3,355	\$4,084

Dimensions			
Height		1,078mm	
Width		800mm	
Depth		1,316mm	

Product Code: SHL5B
1,200mm back, 2 benches, 1 screen, legs

Price	£	€	\$
Group 3	£2,948	€3,261	\$3,969
Group 4	£3,021	€3,341	\$4,067
Group 5	£3,162	€3,496	\$4,256
Group 6	£3,763	€4,161	\$5,066

Dimensions			
Height		1,078mm	
Width		1,200mm	
Depth		1,316mm	

Product Code: SHL6B
1,600mm back, 2 benches, 1 screen, legs

Price	£	€	\$
Group 3	£3,323	€3,675	\$4,473
Group 4	£3,416	€3,778	\$4,599
Group 5	£3,602	€3,983	\$4,849
Group 6	£4,393	€4,858	\$5,914

Dimensions			
Height		1,078mm	
Width		1,600mm	
Depth		1,316mm	

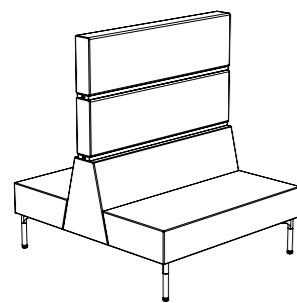

Product Code: SHL4C
800mm back, 2 benches, 2 screens, legs

Price	£	€	\$
Group 3	£2,896	€3,203	\$3,899
Group 4	£2,966	€3,280	\$3,993
Group 5	£3,105	€3,434	\$4,181
Group 6	£3,695	€4,086	\$4,975

Dimensions			
Height		1,443mm	
Width		800mm	
Depth		1,316mm	

Product Code: SHL5C
1,200mm back, 2 benches, 2 screens, legs

Price	£	€	\$
Group 3	£3,382	€3,740	\$4,553
Group 4	£3,470	€3,838	\$4,672
Group 5	£3,649	€4,036	\$4,913
Group 6	£4,410	€4,876	\$5,936

Dimensions			
Height		1,443mm	
Width		1,200mm	
Depth		1,316mm	

Product Code: SHL6C
1,600mm back, 2 benches, 2 screens, legs

Price	£	€	\$
Group 3	£4,068	€4,499	\$5,477
Group 4	£4,186	€4,629	\$5,635
Group 5	£4,422	€4,890	\$5,953
Group 6	£5,427	€6,001	\$7,306

Dimensions			
Height		1,443mm	
Width		1,600mm	
Depth		1,316mm	

Hive Modular Specifications Curved Modules

Product Code: SHL10A
Description: 60° back, internal bench, legs

Price	£	€	\$
Group 3	£1,842	€2,037	\$2,480
Group 4	£1,898	€2,099	\$2,555
Group 5	£2,012	€2,226	\$2,709
Group 6	£2,496	€2,760	\$3,360

Dimensions			
Height		713mm	
Width		1,305mm	
Depth		720mm	

Product Code: SHL11A
Description: 90° back, internal bench, legs

Price	£	€	\$
Group 3	£2,274	€2,516	\$3,062
Group 4	£2,354	€2,603	\$3,169
Group 5	£2,516	€2,782	\$3,387
Group 6	£3,200	€3,539	\$4,308

Dimensions			
Height		713mm	
Width		1,845mm	
Depth		720mm	

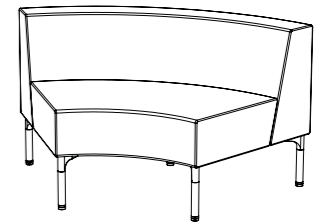

Product Code: SHL10B
Description: 60° back, internal bench, 1 screen, legs

Price	£	€	\$
Group 3	£2,410	€2,665	\$3,244
Group 4	£2,485	€2,748	\$3,345
Group 5	£2,635	€2,915	\$3,548
Group 6	£3,279	€3,626	\$4,415

Dimensions			
Height		1,078mm	
Width		1,305mm	
Depth		720mm	

Product Code: SHL11B
Description: 90° back, internal bench, 1 screen, legs

Price	£	€	\$
Group 3	£2,999	€3,317	\$4,038
Group 4	£3,111	€3,440	\$4,188
Group 5	£3,334	€3,687	\$4,489
Group 6	£4,285	€4,738	\$5,768

Dimensions			
Height		1,078mm	
Width		1,845mm	
Depth		720mm	

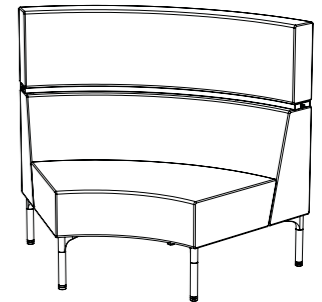

Product Code: SHL10C
Description: 60° back, internal bench, 2 screens, legs

Price	£	€	\$
Group 3	£2,976	€3,292	\$4,007
Group 4	£3,071	€3,396	\$4,135
Group 5	£3,259	€3,605	\$4,388
Group 6	£4,062	€4,492	\$5,469

Dimensions			
Height		1,443mm	
Width		1,305mm	
Depth		720mm	

Product Code: SHL11C
Description: 90° back, internal bench, 2 screens, legs

Price	£	€	\$
Group 3	£3,725	€4,120	\$5,015
Group 4	£3,869	€4,278	\$5,208
Group 5	£4,155	€4,595	\$5,593
Group 6	£5,368	€5,937	\$7,227

Dimensions			
Height		1,443mm	
Width		1,845mm	
Depth		720mm	



Please note: On curved modules measurements are taken across the widest point

Hive Modular Specifications Back-to-Back Curved Modules

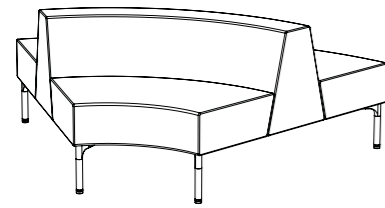

Product Code: SHL13A
Description: 60° back, 2 benches, legs

Price	£	€	\$
Group 3	£3,154	€3,488	\$4,247
Group 4	£3,254	€3,599	\$4,381
Group 5	£3,456	€3,822	\$4,653
Group 6	£4,310	€4,766	\$5,802

Dimensions	
Height	713mm
Width	1,904mm
Depth	1,316mm

Product Code: SHL14A*
Description: 90° back, 2 benches, legs

Price	£	€	\$
Group 3	£3,869	€4,278	\$5,208
Group 4	£4,000	€4,423	\$5,385
Group 5	£4,264	€4,715	\$5,740
Group 6	£5,384	€5,954	\$7,248

Dimensions	
Height	713mm
Width	2,650mm
Depth	1,316mm

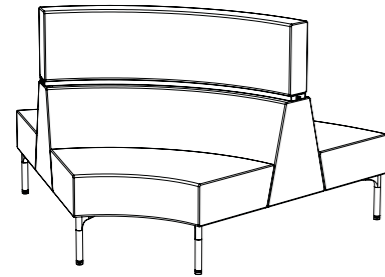

Product Code: SHL13B
Description: 60° back, 2 benches, 1 screen, legs

Price	£	€	\$
Group 3	£3,776	€4,176	\$5,084
Group 4	£3,898	€4,311	\$5,248
Group 5	£4,136	€4,574	\$5,568
Group 6	£5,150	€5,695	\$6,933

Dimensions	
Height	1,078mm
Width	1,904mm
Depth	1,316mm

Product Code: SHL14B*
Description: 90° back, 2 benches, 1 screen, legs

Price	£	€	\$
Group 3	£4,594	€5,080	\$6,184
Group 4	£4,757	€5,261	\$6,404
Group 5	£5,082	€5,621	\$6,842
Group 6	£6,468	€7,152	\$8,707

Dimensions	
Height	1,078mm
Width	2,650mm
Depth	1,316mm

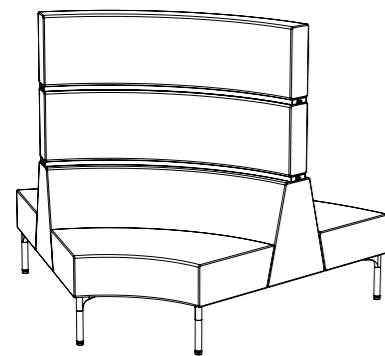

Product Code: SHL13C
Description: 60° back, 2 benches, 2 screens, legs

Price	£	€	\$
Group 3	£4,401	€4,867	\$5,925
Group 4	£4,539	€5,019	\$6,110
Group 5	£4,816	€5,326	\$6,484
Group 6	£5,990	€6,624	\$8,064

Dimensions	
Height	1,443mm
Width	1,904mm
Depth	1,316mm

Product Code: SHL14C*
Description: 90° back, 2 benches, 2 screens, legs

Price	£	€	\$
Group 3	£5,320	€5,883	\$7,161
Group 4	£5,514	€6,098	\$7,423
Group 5	£5,902	€6,527	\$7,945
Group 6	£7,551	€8,351	\$10,166

Dimensions	
Height	1,443mm
Width	2,650mm
Depth	1,316mm

Hive Modular Specifications Corner Modules

Product Code: SHL15
Description: D-end bench, legs

Price	£	€	\$
Group 3	£956	€1,057	\$1,287
Group 4	£981	€1,085	\$1,321
Group 5	£1,031	€1,140	\$1,388
Group 6	£1,237	€1,368	\$1,665

Dimensions	
Height	443mm
Width	1,316mm
Depth	660mm

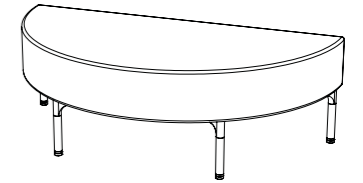

Product Code: SHL16
Description: Quadrant bench, legs

Price	£	€	\$
Group 3	£820	€907	\$1,104
Group 4	£842	€932	\$1,134
Group 5	£888	€983	\$1,196
Group 6	£1,082	€1,196	\$1,456

Dimensions	
Height	433mm
Width	720mm
Depth	720mm

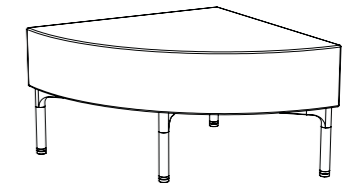

Product Code: SHL7A
Description: Corner back, bench, legs

Price	£	€	\$
Group 3	£1,749	€1,935	\$2,355
Group 4	£1,824	€2,018	\$2,456
Group 5	£1,974	€2,183	\$2,658
Group 6	£2,610	€2,887	\$3,514

Dimensions	
Height	713mm
Width	800mm
Depth	800mm

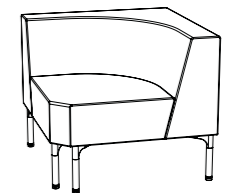

Product Code: SHL7B
Description: Corner back, bench, 1 corner screen, legs

Price	£	€	\$
Group 3	£2,385	€2,637	\$3,211
Group 4	£2,474	€2,736	\$3,331
Group 5	£2,651	€2,932	\$3,569
Group 6	£3,403	€3,763	\$4,581

Dimensions	
Height	1,078mm
Width	800mm
Depth	800mm



Product Code: SHL7C
Description: Corner back, bench, 2 corner screens, legs

Price	£	€	\$
Group 3	£3,021	€3,341	\$4,067
Group 4	£3,122	€3,453	\$4,203
Group 5	£3,328	€3,680	\$4,480
Group 6	£4,196	€4,641	\$5,649

Dimensions	
Height	1,443mm
Width	800mm
Depth	800mm



*On all 90° curved modules the external bench is in 2 pieces
Please note: On curved modules measurements are taken across the widest point

Please note: Standard modules are supplied with 5 legs

Hive Modular Specifications Leg Options

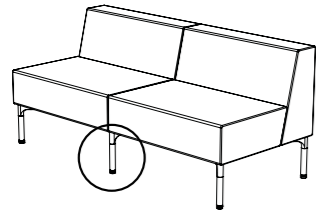

Product Code: SHL17
Description: Single sided shared leg

Price	£	€	\$
	£156	€173	\$210

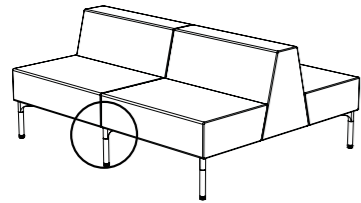

Product Code: SHL18
Description: Back-to-back module shared leg

Price	£	€	\$
	£187	€207	\$252

Hive Modular Specifications T-Modules

Product Code: SHL8A
Description: T-back, benches, legs

Price	£	€	\$	Dimensions
Group 3	£2,969	€3,284	\$3,997	Height 713mm
Group 4	£3,108	€3,437	\$4,184	Width 1,476mm
Group 5	£3,382	€3,740	\$4,553	Depth 800mm
Group 6	£4,550	€5,032	\$6,125	

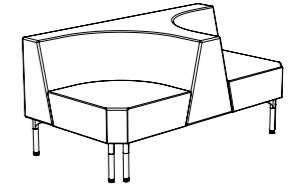

Product Code: SHL8B
Description: T-back, benches, 1 T-screen, legs

Price	£	€	\$	Dimensions
Group 3	£3,879	€4,290	\$5,222	Height 1,078mm
Group 4	£4,047	€4,475	\$5,448	Width 1,476mm
Group 5	£4,382	€4,845	\$5,899	Depth 800mm
Group 6	£5,804	€6,419	\$7,814	

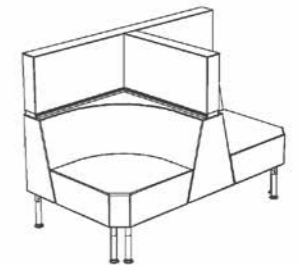

Product Code: SHL8C
Description: T-back, benches, 2 T-screens, legs

Price	£	€	\$	Dimensions
Group 3	£4,845	€5,358	\$6,523	Height 1,443mm
Group 4	£5,043	€5,577	\$6,789	Width 1,476mm
Group 5	£5,438	€6,014	\$7,321	Depth 800mm
Group 6	£7,116	€7,869	\$9,579	

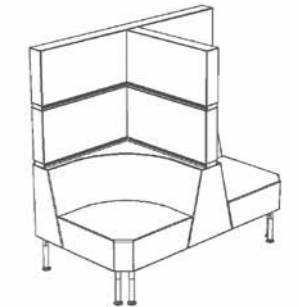

Flock Modular Specifications Single Modules

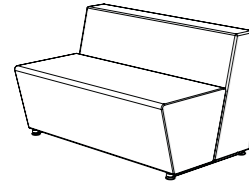

Product Code: SFK0800/FBBX
800mm back, 1 bench, no screen

Price	£	€	\$
Group 3	£1,406	€1,617	\$1,969
Group 4	£1,478	€1,700	\$2,070
Group 5	£1,569	€1,804	\$2,196
Group 6	£1,839	€2,115	\$2,575
Group 7	£2,020	€2,322	\$2,827
Dimensions			
Height			713mm
Width			800mm
Depth			720mm

Product Code: SFK1200/FBBX
1,200mm back, 1 bench, no screen

Price	£	€	\$
Group 3	£1,461	€1,680	\$2,045
Group 4	£1,556	€1,789	\$2,178
Group 5	£1,675	€1,926	\$2,344
Group 6	£2,031	€2,336	\$2,844
Group 7	£2,269	€2,609	\$3,177
Dimensions			
Height			713mm
Width			1,200mm
Depth			720mm

Product Code: SFK1600/FBBX
1,600mm back, 1 bench, no screen

Price	£	€	\$
Group 3	£1,656	€1,904	\$2,318
Group 4	£1,777	€2,044	\$2,488
Group 5	£1,929	€2,218	\$2,700
Group 6	£2,384	€2,742	\$3,338
Group 7	£2,687	€3,090	\$3,762
Dimensions			
Height			713mm
Width			1,600mm
Depth			720mm

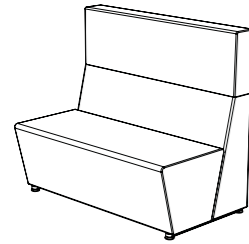

Product Code: SFK0800/FBB1
800mm back, 1 bench, 1 screen

Price	£	€	\$
Group 3	£1,783	€2,051	\$2,497
Group 4	£1,870	€2,151	\$2,619
Group 5	£1,979	€2,276	\$2,771
Group 6	£2,305	€2,651	\$3,227
Group 7	£2,522	€2,901	\$3,531
Dimensions			
Height			1,078mm
Width			800mm
Depth			720mm

Product Code: SFK1200/FBB1
1,200mm back, 1 bench, 1 screen

Price	£	€	\$
Group 3	£1,895	€2,180	\$2,653
Group 4	£2,015	€2,317	\$2,821
Group 5	£2,165	€2,489	\$3,030
Group 6	£2,614	€3,006	\$3,659
Group 7	£2,913	€3,350	\$4,078
Dimensions			
Height			1,078mm
Width			1,200mm
Depth			720mm

Product Code: SFK1600/FBB1
1,600mm back, 1 bench, 1 screen

Price	£	€	\$
Group 3	£2,160	€2,483	\$3,023
Group 4	£2,309	€2,655	\$3,232
Group 5	£2,495	€2,870	\$3,493
Group 6	£3,055	€3,513	\$4,277
Group 7	£3,428	€3,942	\$4,799
Dimensions			
Height			1,078mm
Width			1,600mm
Depth			720mm

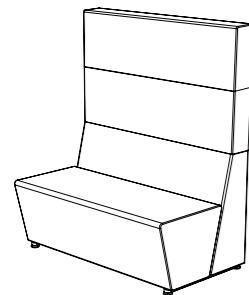

Product Code: SFK0800/FBB2
800mm back, 1 bench, 2 screens

Price	£	€	\$
Group 3	£2,204	€2,525	\$3,086
Group 4	£2,306	€2,652	\$3,228
Group 5	£2,433	€2,798	\$3,406
Group 6	£2,814	€3,236	\$3,940
Group 7	£3,068	€3,529	\$4,296
Dimensions			
Height			1,443mm
Width			800mm
Depth			720mm

Product Code: SFK1200/FBB2
1,200mm back, 1 bench, 2 screens

Price	£	€	\$
Group 3	£2,451	€2,819	\$3,432
Group 4	£2,595	€2,985	\$3,634
Group 5	£2,776	€3,192	\$3,886
Group 6	£3,317	€3,815	\$4,644
Group 7	£3,678	€4,230	\$5,149
Dimensions			
Height			1,443mm
Width			1,200mm
Depth			720mm

Product Code: SFK1600/FBB2
1,600mm back, 1 bench, 2 screens

Price	£	€	\$
Group 3	£2,706	€3,112	\$3,789
Group 4	£2,884	€3,316	\$4,037
Group 5	£3,105	€3,571	\$4,347
Group 6	£3,769	€4,335	\$5,277
Group 7	£4,212	€4,844	\$5,897
Dimensions			
Height			1,443mm
Width			1,600mm
Depth			720mm

Flock Modular Specifications Double Modules

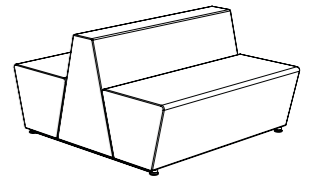

Product Code: SFK0800/DBBX
800mm back, 2 benches, no screen

Price	£	€	\$
Group 3	£1,840	€2,116	\$2,576
Group 4	£1,917	€2,205	\$2,684
Group 5	£2,014	€2,316	\$2,819
Group 6	£2,303	€2,648	\$3,224
Group 7	£2,495	€2,870	\$3,493
Dimensions			
Height			713mm
Width			800mm
Depth			1,316mm

Product Code: SFK1200/DBBX
1,200mm back, 2 benches, no screen

Price	£	€	\$
Group 3	£2,049	€2,356	\$2,868
Group 4	£2,149	€2,471	\$3,008
Group 5	£2,274	€2,615	\$3,183
Group 6	£2,649	€3,046	\$3,708
Group 7	£2,899	€3,334	\$4,058
Dimensions			
Height			713mm
Width			1,200mm
Depth			1,316mm

Product Code: SFK1600/DBBX
1,600mm back, 2 benches, no screen

Price	£	€	\$
Group 3	£2,414	€2,777	\$3,380
Group 4	£2,539	€2,920	\$3,555
Group 5	£2,695	€3,099	\$3,773
Group 6	£3,162	€3,637	\$4,427
Group 7	£3,474	€3,995	\$4,863
Dimensions			
Height			713mm
Width			1,600mm
Depth			1,316mm

Product Code: SFK0800/DBB1
800mm back, 2 benches, 1 screen

Price	£	€	\$
Group 3	£2,217	€2,550	\$3,104
Group 4	£2,309	€2,656	\$3,233
Group 5	£2,424	€2,788	\$3,394
Group 6	£2,768	€3,184	\$3,876
Group 7	£2,998	€3,448	\$4,197
Dimensions			
Height			1,078mm
Width			800mm
Depth			1,316mm

Product Code: SFK1200/DBB1
1,200mm back, 2 benches, 1 screen

Price	£	€	\$
Group 3	£2,483	€2,856	\$3,477
Group 4	£2,608	€2,999	\$3,651
Group 5	£2,764	€3,178	\$3,869
Group 6	£3,231	€3,716	\$4,524
Group 7	£3,543	€4,074	\$4,960
Dimensions			
Height			1,078mm
Width			1,200mm
Depth			1,316mm

Product Code: SFK1600/DBB1
1,600mm back, 2 benches, 1 screen

Price	£	€	\$
Group 3	£2,918	€3,356	\$4,085
Group 4	£3,071	€3,531	\$4,299
Group 5	£3,261	€3,750	\$4,566
Group 6	£3,833	€4,408	\$5,366
Group 7	£4,215	€4,847	\$5,900
Dimensions			
Height			1,078mm
Width			1,600mm
Depth			1,316mm

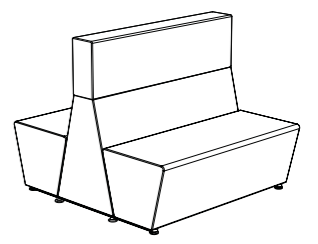

Product Code: SFK0800/DBB2
800mm back, 2 benches, 2 screens

Price	£	€	\$
Group 3	£2,638	€3,034	\$3,693
Group 4	£2,745	€3,156	\$3,842
Group 5	£2,878	€3,310	\$4,029
Group 6	£3,278	€3,769	\$4,589
Group 7	£3,544	€4,076	\$4,962
Dimensions			
Height			1,443mm
Width			800mm
Depth			1,316mm

Product Code: SFK1200/DBB2
1,200mm back, 2 benches, 2 screens

Price	£	€	\$
Group 3	£2,961	€3,405	\$4,146
Group 4	£3,111	€3,577	\$4,355
Group 5	£3,297	€3,792	\$4,616
Group 6	£3,857	€4,435	\$5,399
Group 7	£4,230	€4,864	\$5,922
Dimensions			
Height			1,443mm
Width			1,200mm
Depth			1,316mm

Product Code: SFK1600/DBB2
1,600mm back, 2 benches, 2 screens

Price	£	€	\$
Group 3	£3,465	€3,985	\$4,851
Group 4	£3,645	€4,192	\$5,104
Group 5	£3,871	€4,452	\$5,419
Group 6	£4,547	€5,230	\$6,366
Group 7	£4,998	€5,748	\$6,998
Dimensions			
Height			1,443mm
Width			1,600mm
Depth			1,316mm

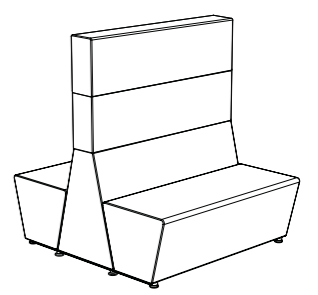

Flock Modular Specifications Corner Modules

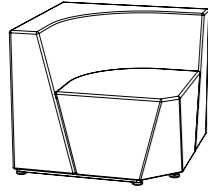

Product Code: SFKCORN/FBBX
Corner back, bench, no screen

Price	£	€	\$	Dimensions
Group 3	£1,696	€1,950	\$2,374	Height 713mm
Group 4	£1,810	€2,082	\$2,534	Width 800mm
Group 5	£1,954	€2,247	\$2,735	Depth 800mm
Group 6	£2,384	€2,742	\$3,338	
Group 7	£2,671	€3,072	\$3,740	

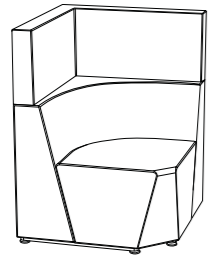

Product Code: SFKCORN/FBB1
Corner back, bench, 1 screen

Price	£	€	\$	Dimensions
Group 3	£2,416	€2,779	\$3,383	Height 1,078mm
Group 4	£2,577	€2,964	\$3,608	Width 800mm
Group 5	£2,778	€3,195	\$3,889	Depth 800mm
Group 6	£3,381	€3,888	\$4,733	
Group 7	£3,782	€4,350	\$5,295	

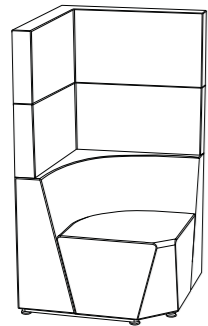

Product Code: SFKCORN/FBB2
Corner back, bench, 2 screen

Price	£	€	\$	Dimensions
Group 3	£3,185	€3,663	\$4,459	Height 1,443mm
Group 4	£3,392	€3,900	\$4,748	Width 800mm
Group 5	£3,650	€4,197	\$5,110	Depth 800mm
Group 6	£4,425	€5,088	\$6,195	
Group 7	£4,941	€5,683	\$6,918	

Flock Modular Specifications Curved Modules

Product Code: SFK90DG/FBBX
90 degree curved internal bench, legs, no screen

Price	£	€	\$	Dimensions
Group 3	£1,964	€2,259	\$2,750	Height 713mm
Group 4	£2,104	€2,419	\$2,945	Width 1,850mm
Group 5	£2,278	€2,619	\$3,189	Depth 720mm
Group 6	£2,801	€3,221	\$3,921	
Group 7	£3,149	€3,621	\$4,409	

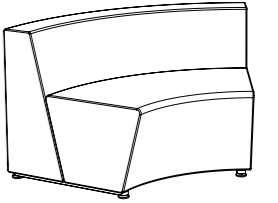

Product Code: SFK90DG/FBB1
90 degree curved internal bench, legs, 1 screen

Price	£	€	\$	Dimensions
Group 3	£2,522	€2,900	\$3,530	Height 1,078mm
Group 4	£2,699	€3,104	\$3,778	Width 1,850mm
Group 5	£2,920	€3,358	\$4,088	Depth 720mm
Group 6	£3,584	€4,122	\$5,018	
Group 7	£4,027	€4,631	\$5,638	

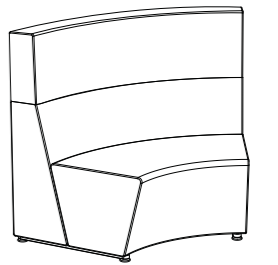

Product Code: SFK90DG/FBB2
90 degree curved internal bench, legs, 2 screen

Price	£	€	\$	Dimensions
Group 3	£3,122	€3,591	\$4,371	Height 1,443mm
Group 4	£3,337	€3,838	\$4,672	Width 1,850mm
Group 5	£3,606	€4,147	\$5,048	Depth 720mm
Group 6	£4,411	€5,073	\$6,176	
Group 7	£4,948	€5,691	\$6,928	

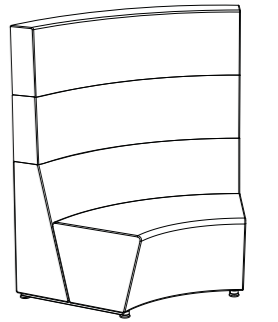



Flock Auditorium Specifications Modules

Product Code: SFK0800/
800mm back, 1 screen, 1 worksurface

Price	£	€	\$
Group 3	£2,066	€2,376	\$2,893
Group 4	£2,153	€2,476	\$3,015
Group 5	£2,261	€2,601	\$3,166
Group 6	£2,587	€2,976	\$3,622
Group 7	£2,805	€3,226	\$3,927

Dimensions	
Height	1,077mm
Width	800mm
Depth	720mm
Weight	37kg

Product Code: SFK1200/
1,200mm back, 1 screen, 1 worksurface

Price	£	€	\$
Group 3	£2,403	€2,764	\$3,365
Group 4	£2,523	€2,902	\$3,533
Group 5	£2,672	€3,073	\$3,741
Group 6	£3,121	€3,590	\$4,370
Group 7	£3,421	€3,935	\$4,790

Dimensions	
Height	1,077mm
Width	1,200mm
Depth	720mm
Weight	43kg

Product Code: SFK1600/
1,600mm back, 1 screen, 1 worksurface

Price	£	€	\$
Group 3	£2,676	€3,078	\$3,747
Group 4	£2,825	€3,249	\$3,955
Group 5	£3,012	€3,464	\$4,217
Group 6	£3,571	€4,107	\$5,000
Group 7	£3,944	€4,536	\$5,522

Dimensions	
Height	1,077mm
Width	1,600mm
Depth	720mm
Weight	54kg

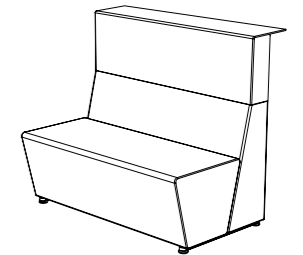

Product Code: SFK90DG/
Description: 90 Degree back, 1 screen, 1 worksurface

Price	£	€	\$
Group 3	£3,280	€3,722	\$4,592
Group 4	£3,456	€3,975	\$4,839
Group 5	£3,675	€4,227	\$5,145
Group 6	£4,333	€4,983	\$6,067
Group 7	£4,772	€5,488	\$6,681

Dimensions	
Height	1,077mm
Width	1,200mm
Depth	720mm
Weight	51kg

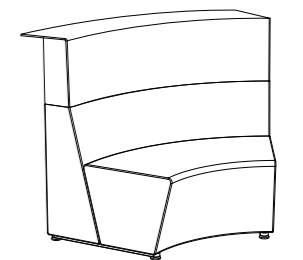

Product Code: SFK60DG/
Description: 60 Degree back, 1 screen, 1 worksurface

Price	£	€	\$
Group 3	£2,730	€3,140	\$3,822
Group 4	£2,858	€3,287	\$4,002
Group 5	£2,018	€3,471	\$4,226
Group 6	£3,498	€4,023	\$4,898
Group 7	£3,818	€4,391	\$5,346

Dimensions	
Height	1,077mm
Width	1,600mm
Depth	720mm
Weight	73kg

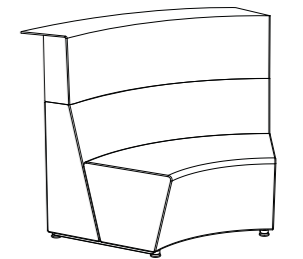

Please note: When ordering Flock Auditorium please specify Left (AUDL), Right (AUDR), or Centre (AUDC) top depending on the desired configuration. All configs must start and finish with a Left and Right module.



Horizon Modular Specifications Modules

Product Code: SHZ9
Description: Small D-end bench

Price	£	€	\$
Group 3	£1,280	€1,416	\$1,724
Group 4	£1,330	€1,471	\$1,791
Group 5	£1,431	€1,583	\$1,927
Group 6	£1,852	€2,049	\$2,494
Group 7	£2,025	€2,240	\$2,726

Dimensions	
Height	730mm
Width	1,360mm
Depth	680mm
Seat Height	400mm
Weight	38kg

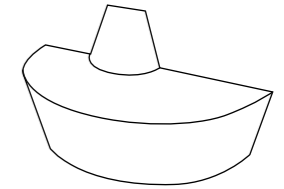

Product Code: SHZ10
Description: Large D-end bench

Price	£	€	\$
Group 3	£2,371	€2,622	\$3,192
Group 4	£2,476	€2,739	\$3,334
Group 5	£2,667	€2,949	\$3,590
Group 6	£3,355	€3,710	\$4,517
Group 7	£4,090	€4,523	\$5,507

Dimensions	
Height	730mm
Width	1,900mm
Depth	980mm
Seat Height	400mm
Weight	45kg

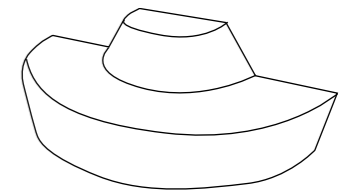

Product Code: SHZ11
Description: 90° bench

Price	£	€	\$
Group 3	£2,026	€2,241	\$2,728
Group 4	£2,118	€2,343	\$2,852
Group 5	£2,284	€2,526	\$3,075
Group 6	£2,885	€3,191	\$3,884
Group 7	£3,933	€4,350	\$5,295

Dimensions	
Height	730mm
Width	1,200mm
Depth	1,200mm
Seat Height	400mm
Weight	47kg

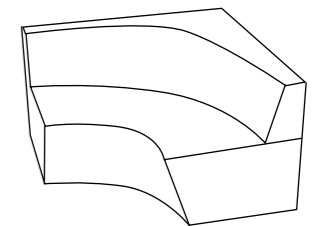

Horizon Modular Specifications Modules

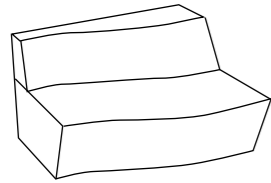

Product Code: SHZ1
Description: Right-hand wave bench

Price	£	€	\$
Group 3	£1,695	€1,875	\$2,282
Group 4	£1,769	€1,957	\$2,382
Group 5	£1,918	€2,121	\$2,582
Group 6	£2,550	€2,820	\$3,433
Group 7	£2,811	€3,109	\$3,785

Dimensions	
Height	730mm
Width	1,200mm
Depth	980mm
Seat Height	400mm
Weight	44kg

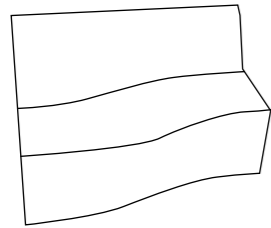

Product Code: SHZ2
Description: Left-hand wave bench

Price	£	€	\$
Group 3	£1,695	€1,875	\$2,282
Group 4	£1,769	€1,957	\$2,382
Group 5	£1,918	€2,121	\$2,582
Group 6	£2,550	€2,820	\$3,433
Group 7	£2,811	€3,109	\$3,785

Dimensions	
Height	730mm
Width	1,200mm
Depth	980mm
Seat Height	400mm
Weight	44kg

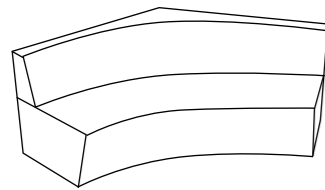

Product Code: SHZ5
Description: 120° 1,200mm bench

Price	£	€	\$
Group 3	£2,688	€2,973	\$3,619
Group 4	£2,799	€3,095	\$3,768
Group 5	£2,995	€3,312	\$4,032
Group 6	£3,708	€4,100	\$4,991
Group 7	£4,480	€4,955	\$6,032

Dimensions	
Height	730mm
Width	2,075mm
Depth	1,182mm
Seat Height	400mm
Weight	55kg

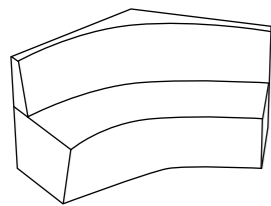

Product Code: SHZ6
Description: 120° 900mm bench

Price	£	€	\$
Group 3	£2,104	€2,327	\$2,833
Group 4	£2,196	€2,429	\$2,957
Group 5	£2,363	€2,613	\$3,181
Group 6	£2,963	€3,277	\$3,989
Group 7	£4,010	€4,435	\$5,399

Dimensions	
Height	730mm
Width	1,560mm
Depth	1,040mm
Seat Height	400mm
Weight	46kg

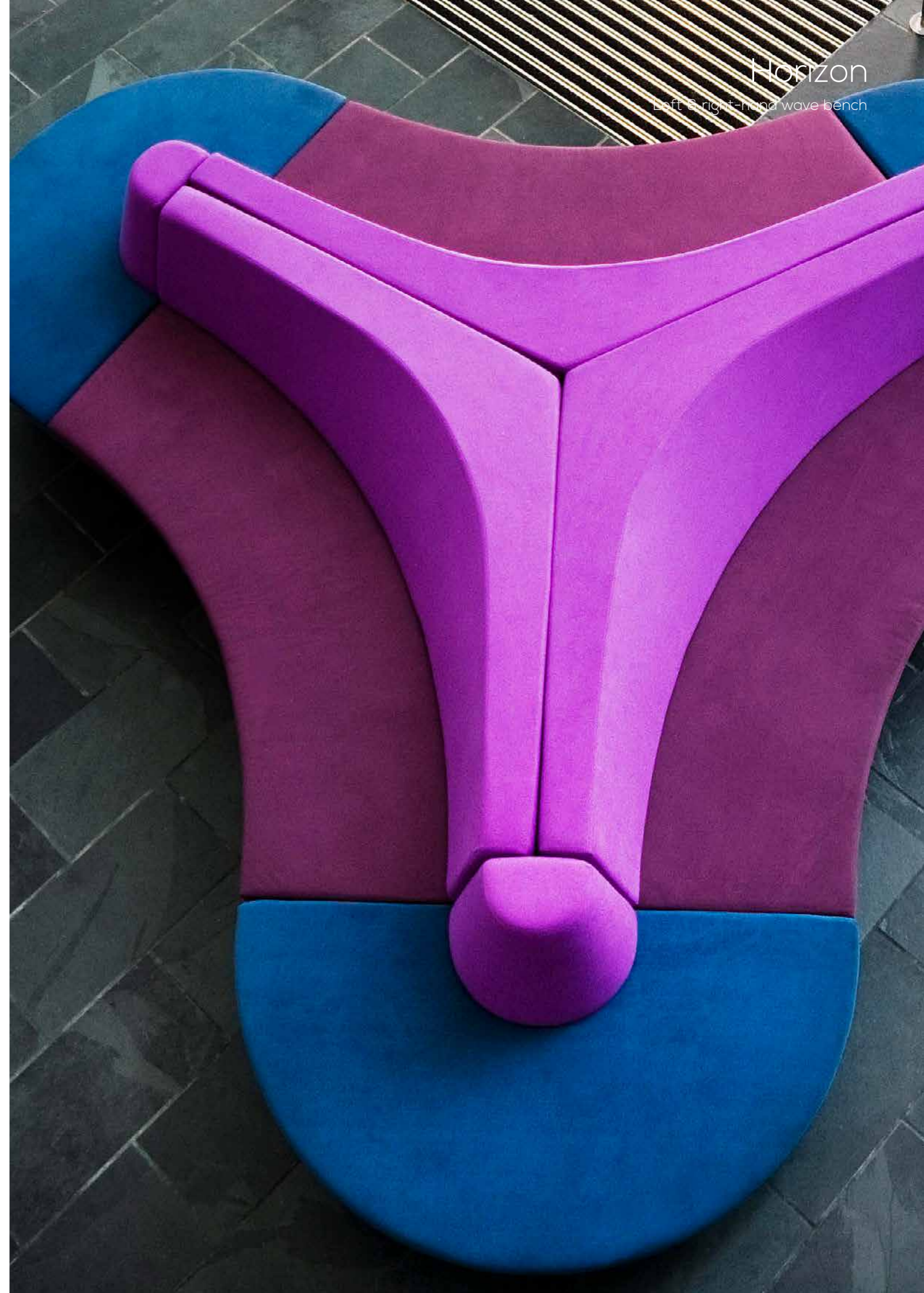

Tier

12 seat configuration



Tier Modular Specifications Modules

Product Code: STE1

Description: Straight 3-tier seating module with upholstery & floor covering, including back balustrade

Price	£	€	\$	Price	£	€	\$	Dimensions	
Group 0	£5,174	€5,722	\$6,965	Group 4	£5,392	€5,963	\$7,259	Height	2,034mm
Group 1	£5,221	€5,773	\$7,028	Group 5	£5,470	€6,049	\$7,364	Width	1,200mm
Group 2	£5,283	€5,842	\$7,112	Group 6	£5,704	€6,308	\$7,679	Depth	1,770mm
Group 3	£5,330	€5,894	\$7,175	Group 7	£5,806	€6,481	\$7,889	Seat Height	435/785/1,135mm

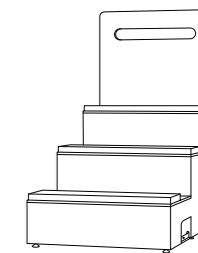

Product Code: STE2

Description: Angled 3-tier seating module with upholstery & floor covering, including back balustrade

Price	£	€	\$	Price	£	€	\$	Dimensions	
Group 0	£5,253	€5,809	\$7,072	Group 4	£5,471	€6,051	\$7,366	Height	2,034mm
Group 1	£5,300	€5,861	\$7,135	Group 5	£5,549	€6,137	\$7,471	Width	600-1,200mm
Group 2	£5,362	€5,930	\$7,219	Group 6	£5,783	€6,396	\$7,786	Depth	1,770mm
Group 3	£5,409	€5,982	\$7,282	Group 7	£5,939	€6,568	\$7,996	Seat Height	435/785/1,135mm

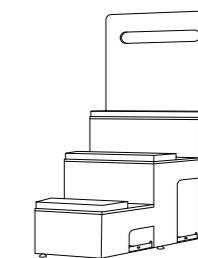

Product Code: STE3

Description: Stepped access module with floor covering, including back balustrade

Price	£	€	\$	Dimensions	
	£3,285	€3,633	\$4,423	Height	2,034mm
				Width	600mm
				Depth	1,770mm

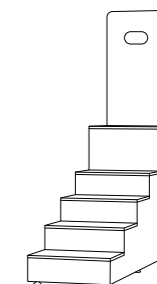

Product Code: STE4

Description: End of run balustrade

Price	£	€	\$	Dimensions	
	£1,668	€1,845	\$2,246	Height	2,034mm
				Depth	1,770mm

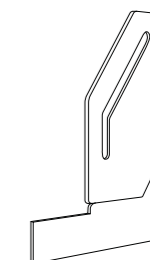

Additional Options: Tier modules minus back balustrade

Disclaimer: Tier units without balustrades must be positioned against a wall in order to meet health and safety requirements. Connection will not be held accountable for any issues resulting from balustrades being omitted

Price	£	€	\$
STE1	-£546	-€603	-\$735
STE2	-£546	-€603	-\$735
STE3	-£359	-€396	-\$483

Material Finishes

Metal Finishes



Metal Colour Options: Tubes Tables & Chairs

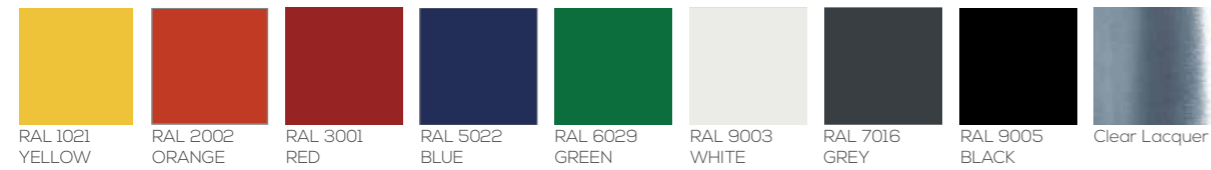

Wood Finishes

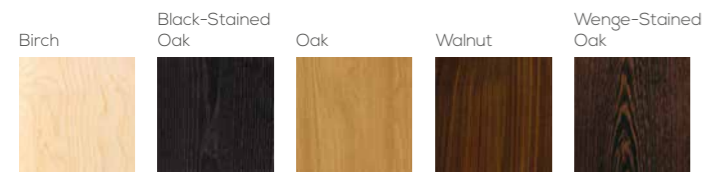

Flooring Options: Platforms



Acoustic Baffles Options: Rooms



*Other baffles colour options are available. POA.

Please note: Not all options are available on every product - please contact your local representative

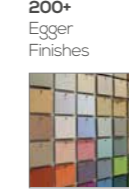

Table Top Finishes

Standard Melamine Finishes:



Standard Laminate Finishes:



For the full range of laminate finishes available please visit: www.egger.com

Please note: not all of Egger's laminate options are available, please speak to your account manager or our customer service team



FENIX^{NTM}

Table Top Finishes

Fenix NTM Laminate Finishes:



Fabric Specifications

General Fabric & Leather Options

Group 1

Supplier	Range
Camira	Advantage
Camira	Canopy
Camira	Era
Camira	Gravity
Camira	Manhattan
Camira	Phoenix
Camira	Rivet
Camira	Sprint
Camira	Xtreme
Chieftain	Trimcell Classic V
Gabriel	Event
Gabriel	Fighter
Macflex	Oporto V

Group 2

Supplier	Range
Agua	Cashmir
Agua	Fusion
Agua	Taurus
Camira	Aspect
Camira	Honeycomb
Camira	Mainline Flax
Camira	Mainline Plus
Camira	Manila V
Camira	Oceanic
Camira	Patina
Camira	Urban
Camira	Vita V
Camira	X2
Cheftain	Just Colour V
Gabriel	Step
Macflex	Delta V
Panaz	Aston V
Panaz	Highland
Spradling	Valencia V

Group 3

Supplier	Range
Camira	Blazer
Camira	Halcyon - Aspen and Blossom
Camira	Nexus
Camira	Synergy
Gabriel	Crisp
Gabriel	Europost
Gabriel	Gaja Classic
Gabriel	Step Melange
Gabriel	Gaja C2C
Kvadrat	Canvas
Kvadrat	Field
Kvadrat	Remix
Kvadrat	Umani / 2 / 3
Moon	Spectrum
Panaz	Allure
Skai	Tundra V
Spectrum	Colour Pallett V
Vescom	Cres
Vescom	Samar

Group 4

Supplier	Range
Camira	24/7 +
Camira	24/7 Flax
Camira	Aquarius
Camira	Intervene
Camira	Landscape
Camira	Silk
Camira	Track
Camira	Zap
Gabriel	Fame
Kvadrat	Clara 2
Skai	Sortega V
Vescom	Brant V
Vescom	Cyprus V
Vescom	Leone V

Group 5

Supplier	Range
Bute	Elgin
Camira	Craggan
Camira	Individuo
Camira	Yoredale
Ultrafabrics	Brisa V
Ultrafabrics	Ultra Leather Pro V
Ultrafabrics	Ultra Leather Original V
Vescom	Hestan
Vescom	Ponza

Group 6

Supplier	Range
Bute	Melrose
Bute	Tweed
Camira	Armadillo
Camira	Corrosion
Camira	Nettle Aztec
Camira	Synergy Quilt
Kvadrat	Divina 3
Kvadrat	Divina Melange
Kvadrat	Melange Nap
Kvadrat	Re-Wool
Kvadrat	Rime
Kvadrat	Steelcut 2
Kvadrat	Steelcut Trio
Kvadrat	Tonica 2
Ultrafabrics	Fusion V
Vescom	Ariana
Vescom	Lani

Group 7

Supplier	Range
Gabriel	Comfort
Kvadrat	Hallingdal 65
Kvadrat	Twil Weave

Leather 1

Supplier	Range
Crest	Shelley
Yarwood	Camden
Yarwood	Style

Leather 2

Supplier	Range
Crest	Vele
Yarwood	Capri
Yarwood	Mustang

Leather 3

Supplier	Range
Andrew Muirhead	Grampian
Andrew Muirhead	Ingleston
Andrew Muirhead	Lustrana
Andrew Muirhead	Sateen

V = Vinyl

Fabric Specifications

Hive & Cubbi Fabric Options

Hive & Flock

Group 3

Supplier	Range
Abbotsford	Feast
Camira	24/7 Flax
Camira	Blazer
Camira	Halcyon - Aspen and Blossom
Camira	Mainline Plus
Camira	Mainline Flax
Camira	Synergy
Gabriel	Europost
Gabriel	Gaja Classic
Gabriel	Step Melange
Moon	Spectrum
Panaz	Aston V
Spectrum	Colour Pallett V

Group 4

Supplier	Range
Gabriel	Fame
Vescom	Cyrus V
Vescom	Leone V
Vescom	Malta V

Group 5

Supplier	Range
Camira	Craggan
Camira	Nettle Aztec
Gabriel	Gaja C2C
Ultra	Brisa V
Ultra	Ultra Leather V
Vescom	Ambu
Vescom	Hestan
Vescom	Honshu
Vescom	Lindau
Vescom	Yuma

Hygge

Group 3

Supplier	Range
Camira	Blazer
Camira	Mainline Plus
Camira	Nexus
Camira	Mainline Flax
Camira	Synergy
Gabriel	Europost
Gabriel	Gaja Classic
Gabriel	Step Melange
Kvadrat	Field
Moon	Spectrum
Vescom	Samar

Group 4

Supplier	Range
Camira	Aquarius
Camira	Intervene
Camira	Landscape
Camira	Silk
Gabriel	Fame
Kvadrat	Clara
Ultrafabrics	Ultra Leather Original V

Group 5

Supplier	Range
Cheftain	Lionella V
Cheftain	Multi Stretch V
Kvadrat	Tonica 2
Ultrafabrics	Brisa V
Vescom	Yuma

Group 6

Supplier	Range
Camira	Nettle Aztec
Kvadrat	Divina 3
Kvadrat	Divina Melange
Kvadrat	Rime
Kvadrat	Steelcut
Kvadrat	Steelcut Trio
Kvadrat	Tonica 2
Ultrafabrics	Fusion V
Vescom	Lani

Group 7

Supplier	Range
Gabriel	Comfort
Gabriel	Gaja C2C
Gabriel	Luna
Kvadrat	Hallingdal 65

Cubbi

Group 3

Supplier	Range
Camira	Blazer
Camira	Synergy
Gabriel	Europost
Moon	Spectrum

Group 4

Supplier	Range
Camira	Landscape

Group 6

Supplier	Range
Abbotsford	Exhilarate
Kvadrat	Divina 3
Kvadrat	Divina Melange
Kvadrat	Steelcut
Ultra	Fusion V
Vescom	Ariana
Vescom	Bowen
Vescom	Keros
Vescom	Lani

Group 7

Supplier	Range
Gabriel	Comfort
Gabriel	Luna
Kvadrat	Highfield

Pear & Eclipse

Group 3

Supplier	Range
Camira	Blazer
Camira	Mainline Plus
Camira	Mainline Flax
Camira	Synergy
Gabriel	Europost
Gabriel	Gaja Classic
Gabriel	Step Melange
Gabriel	Gaja C2C
Moon	Spectrum

Group 4

Supplier	Range
Camira	Aquarius
Camira	Landscape

Group 5

Supplier	Range
Ultrafabrics	Brisa V
Ultrafabrics	Ultra Leather Original V

Group 6

Supplier	Range
Kvadrat	Divina 3
Kvadrat	Divina Melange
Ultrafabrics	Fusion V
Vescom	Lani

V = Vinyl

Power & Data Specifications - UK & Ireland

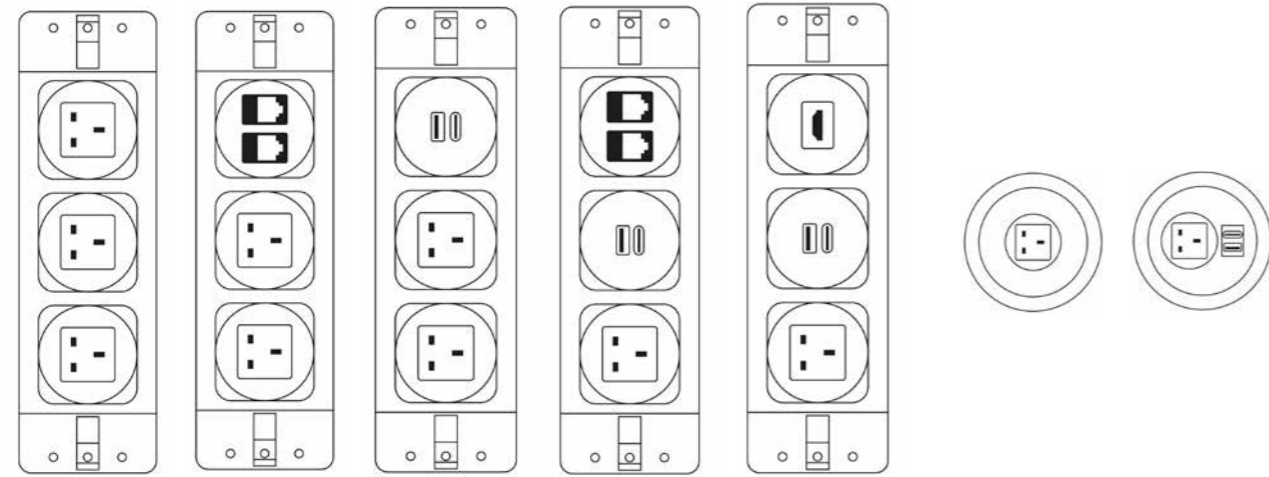

Power Type	Type A	Type C	Type D	Type E	Type F	Type G	Type H
Description	3 UK fused power sockets	1 dual CAT6 unshielded data socket & 2 UK fused power sockets	1 dual USB charger & 2 UK fused power sockets	1 dual CAT6 unshielded data, 1 dual USB charger & 1 UK fused power socket	1 HDMI, 1 dual USB charger & 1 UK fused power socket	1 UK power socket	1 UK power socket & dual USB charger
Power Cable	5.0m	5.0m	5.0m	5.0m	5.0m	5.0m	5.0m
Price	£ € \$	£ € \$	£ € \$	£ € \$	£ € \$	£ € \$	£ € \$
Centro	£157 €181 \$220	£299 €344 \$419	£241 €278 \$338	£405 €466 \$567	£513 €590 \$719	- - -	- - -
Cubbi	£157 €181 \$220	£299 €344 \$419	£241 €278 \$338	£405 €466 \$567	£513 €590 \$719	- - -	- - -
Hive	£157 €181 \$220	£299 €344 \$419	£241 €278 \$338	£405 €466 \$567	£513 €590 \$719	- - -	- - -
Platforms	- - -	- - -	- - -	- - -	- - -	£146 €168 \$205	£186 €214 \$261
Rooms	£228 €263 \$320	£398 €458 \$558	£340 €391 \$476	£504 €580 \$706	£611 €703 \$856	- - -	- - -
Tryst	£157 €181 \$220	£299 €344 \$419	£241 €278 \$338	£405 €466 \$567	£513 €590 \$719	£146 €168 \$205	£186 €214 \$261
Co.Table	£ € \$	£ € \$	£ € \$	£ € \$	£ € \$	£ € \$	£ € \$
X2 Sets	£314 €362 \$440	£598 €688 \$838	£482 €555 \$675	£810 €932 \$1,134	£1,026 €1,180 \$1,437	- - -	- - -
X3 Sets	£471 €542 \$660	£897 €1,032 \$1,256	£723 €832 \$1,013	£1,215 €1,398 \$1,701	£1,539 €1,770 \$2,155	- - -	- - -

Key

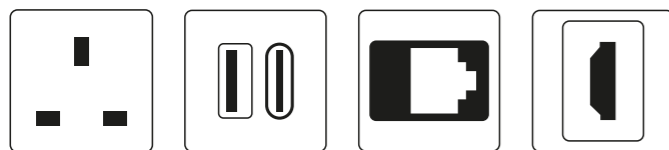

UK fused power socket Dual USB charger CAT 6 unshielded data socket HDMI

Each power unit comes with a 5m power cable and a single country specific plug. If data units are selected each data cable is 3m. It may be possible to consolidate all of the power units to run from a single power cable. Please contact customer services.

Power & Data Specifications - Europe

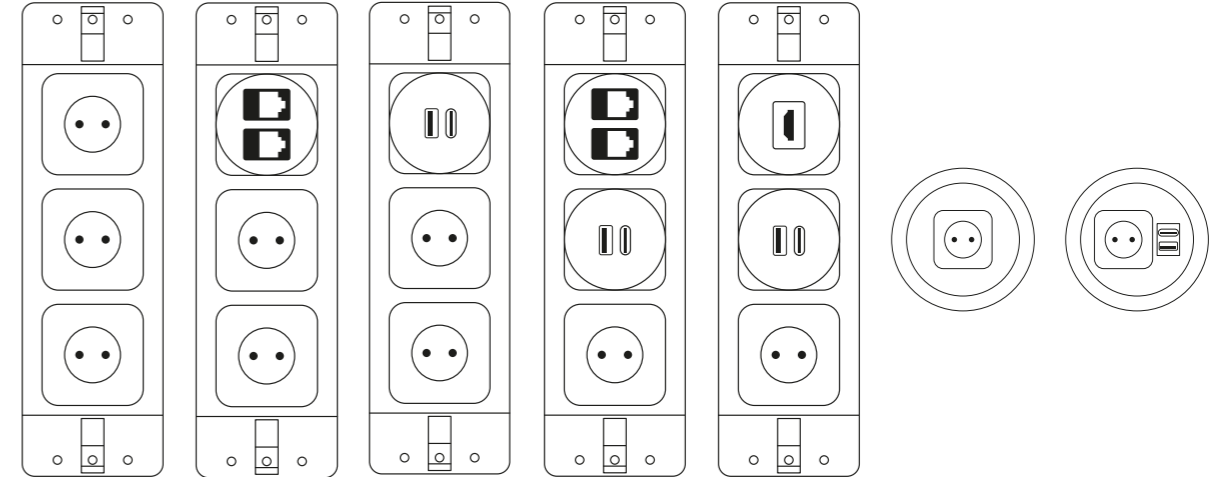

Power Type	Type A	Type C	Type D	Type E	Type F	Type G	Type H
Description	3 European fused power sockets	1 dual CAT6 unshielded data socket & 2 European fused power sockets	1 dual USB charger & 2 European fused power sockets	1 dual CAT6 unshielded data, 1 dual USB charger & 1 European fused power socket	1 HDMI, 1 dual USB charger & 1 European fused power socket	1 European power socket	1 European power socket & dual USB charger
Power Cable	5.0m	5.0m	5.0m	5.0m	5.0m	5.0m	5.0m
Price	€ \$	€ \$	€ \$	€ \$	€ \$	€ \$	€ \$
Centro	€181 \$220	€344 \$419	€278 \$338	€466 \$567	€590 \$719	- -	- -
Cubbi	€181 \$220	€344 \$419	€278 \$338	€466 \$567	€590 \$719	- -	- -
Hive	€181 \$220	€344 \$419	€278 \$338	€466 \$567	€590 \$719	- -	- -
Platforms	- -	- -	- -	- -	- -	€168 \$205	€214 \$205
Rooms	€263 \$320	€458 \$558	€391 \$476	€580 \$706	€703 \$856	- -	- -
Tryst	€181 \$220	€344 \$419	€278 \$338	€466 \$567	€590 \$719	€168 \$205	€214 \$205
Co.Table	€ \$	€ \$	€ \$	€ \$	€ \$	€ \$	€ \$
X2 Sets	€362 \$440	€688 \$838	€555 \$675	€932 \$1,134	€1,180 \$1,437	- -	- -
X3 Sets	€542 \$660	€1,032 \$1,256	€832 \$1,013	€1,398 \$1,701	€1,770 \$2,155	- -	- -

Key

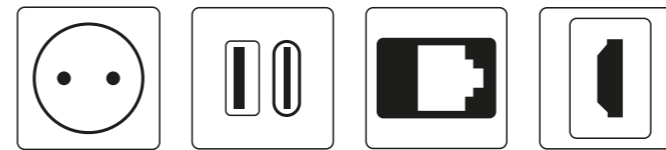

European fused power socket Dual USB charger CAT 6 unshielded data socket HDMI

Each power unit comes with a 5m power cable and a single country specific plug. If data units are selected each data cable is 3m. It may be possible to consolidate all of the power units to run from a single power cable. Please contact customer services.

Power & Data Specifications - Peak Power

Power Module Positions



Peak Power 60 is a new 6 socket power and data connectivity unit for the Centro & Centro Rustic table range.

Installation

Peak Power is designed to fit into a 193mm x 132mm cut-out, suitable for table tops 10mm-30mm thick, and is secured by the supplied 4 x screw clamps.

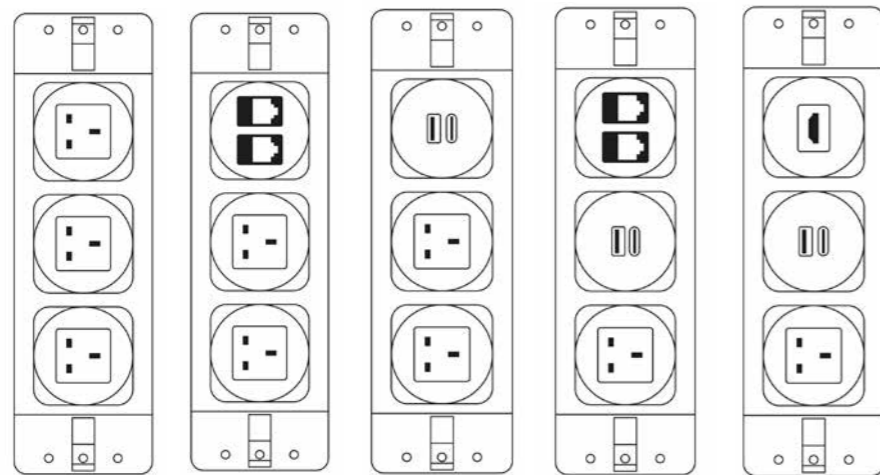

Power Type	Type A	Type C	Type D	Type E	Type F
Description	3 UK fused power sockets	1 dual CAT6 unshielded data socket & 2 UK fused power sockets	1 dual USB charger & 2 UK fused power sockets	1 dual CAT6 unshielded data, 1 dual USB charger & 1 UK fused power socket	1 HDMI, 1 dual USB charger & 1 UK fused power socket
Power Cable	5.0m	5.0m	5.0m	5.0m	5.0m
Price	£ € \$	£ € \$	£ € \$	£ € \$	£ € \$
Centro Rustic	£540 €621 \$756	£790 €909 \$1,106	£760 €874 \$1,064	£1,150 €1,323 \$1,610	£1,350 €1,553 \$1,890

Co.Table

The following diagrams illustrate the standard positions for power modules and lamp stems on both 2591mm and 3988mm Co.Table power management rails, for power types A-E. Please contact your local representative for more information.

2600mm table without lamps

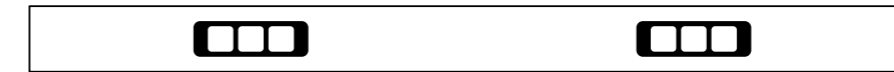

2600mm table & COLAMP-2

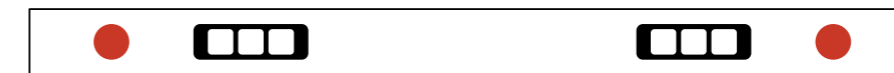

3200mm table without lamps



3200mm table & COLAMP-2

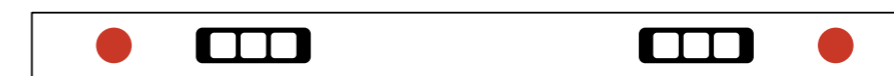

3990mm table without lamps



3990mm table & COLAMP-2

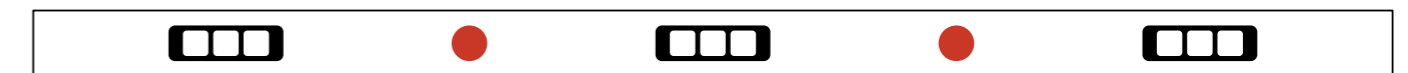

Key
Power modules
Lamp positions

Rooms

The following standard power module positions can be applied to any Rooms configuration; for power types A-E. Any amount of legs in each configuration can hold power, but only one position available per leg. Please contact your local representative for more information.

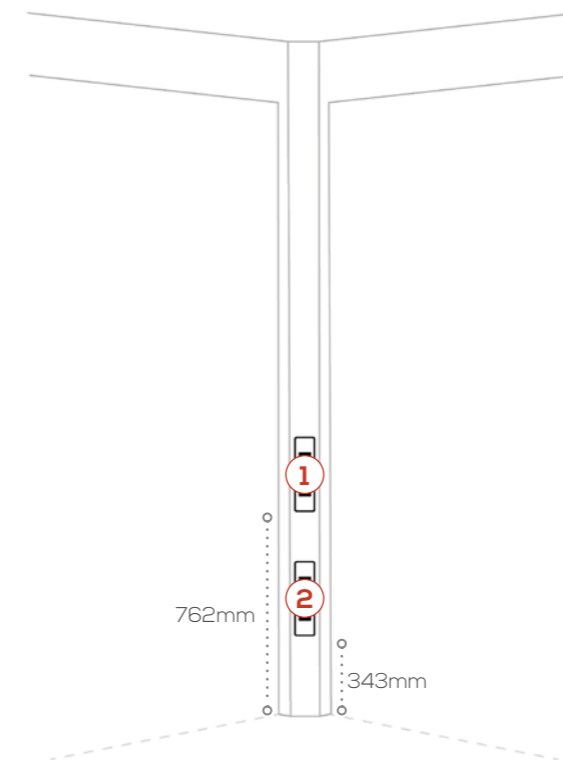

1 High power position (30in from floor)
2 Low power position (13.5in from floor)



Ordering Guidelines

Pricing

All prices shown in sterling (£), euro (€), & dollar (\$) are subject to VAT. Prices are valid from 1st February 2020.

Terms of Payment

Net 30 days from the date of invoice. Connection retains title and ownership of all goods until they have been paid for in full.

Acknowledgement of Orders

All orders will be acknowledged. Please check acknowledgements and contact customer services as soon as possible if there are any amendments to your order. Connection cannot be held responsible for customer error or omissions. Once an order acknowledgement has been sent, the order will go into production. Any amendments received after this date may be chargeable.

On receipt of a clean order, an order acknowledgement will be issued within 24 hours. Should further information be required to place your order, you will be contacted within 24 hours of the enquiry being received. We will clearly indicate the information that is required for the order to be placed.

Ordering Procedure

Orders must be placed in writing and include the following:

- Product code (with options e.g. mechanism, arm-type and colour, base type and colour)
- Fabric range and code
- Quantity
- Delivery address
- Desired delivery date

Please make all orders as clear as possible as this will enable us to provide a more efficient delivery.

Delivery Lead Times

Standard products: Our standard lead time is 5 weeks (plus delivery), from receipt of a clean order. The lead time will depend on a number of factors including fabric choice and size of order. We recommend that you state a required delivery date on your purchase order.

Special products: Lead times for special options are between 6 and 8 weeks, depending on the nature of the special request. Should an order include both standard and special product, the lead time on all products will default to the longest lead time.

Please contact our customer services team or your sales manager for current lead time information.

Once an order is received, Connection will provide an acknowledgement containing a week-ending delivery date. Please note that if the dates on your order acknowledgement do not meet your expectation, you should always contact the customer services team who are happy to explore potential ways to reschedule or improve the dates.

Delivery is in addition to the lead times above and lead times begin once the order acknowledgement is issued.

Specification

All dimensions and weights are approximate; whilst every care is taken to ensure their accuracy, Connection cannot be held responsible for errors. Connection reserve the right to make, without notice, any changes to materials, specifications or design of the products which it considers to be reasonable or desirable. Such changes shall not affect the validity of the contract. Connection reserves the right to amend or change the pricing structure within this publication. Our website has our full policies on guarantee, delivery, continuity of supply and our customer service charter.

Fabric Specification

All products manufactured by Connection are upholstered and assembled to the highest standard. However, due to the characteristics and performance of certain fabrics the final appearance and finish on the product may be adversely affected by the fabric specified. Where a material is specified for a product which may have properties that do not meet the necessary requirements, our customer service team will contact you, advising you of any issues. If you decide to proceed with the chosen fabric, then Connection cannot be held responsible for issues relating directly to the material.

Whilst every effort is made to ensure parity of colour on our fabric finishes, the company cannot guarantee an exact match on any fabric.

Where a customer is supplying their own fabric, and the fabric does not appear in the Connection fabric matrix the following shall apply:

- £150 patterning charge to cover creating templates
- A quantity of fabric must be supplied to Connection to facilitate creating new templates - 5m per soft seating product; 2m per task/meeting product. For larger sofas a greater quantity may be required. This fabric will be used in the templating/design process
- Once the fabric is approved, the order will be processed on standard lead time (starting from the date of approval)
- In the event that the fabric is deemed unsuitable for the requested product, the patterning charge will be refundable

Delivery & Returns

Delivery Schedules

All standard Connection deliveries are made on tailgated vehicles to the designated warehouse of the customer. The standard delivery service operates Monday to Friday, with deliveries to a customer's warehouse between 7am and 7pm.

Connection delivers to mainland UK postcodes on a fortnightly schedule with the majority of areas delivered weekly at our discretion. On receipt of your official purchase order, an order acknowledgement will be returned to you detailing the week ending your delivery will be made. Our customer services team will contact you between 24 and 48 hours prior to book the delivery in.

Small Order Charges

For a customer warehouse delivery, where the net order value is below £500, a charge of £50 will be applied. All small order deliveries will be made in line with our scheduled tailgate delivery.

Direct Deliveries

Where requested, deliveries can be made direct to site. For specific deliveries with a net order value between £5,000 and £10,000 there will be no delivery charge providing the delivery is made in line with our scheduled tailgate delivery.

For all specific deliveries where the net order value is below £5,000, a fee of £150 will be applied to all direct delivery requests. The delivery day for such deliveries will be in line with our scheduled tailgate delivery program.

Requests for a specific delivery date and time can also be facilitated; however additional charges will be made to meet this requirement. Details of the specific costs will depend on the size of delivery and the date required. Full details of these can be obtained through our customer services team.

Large Deliveries

On deliveries where the individual delivery is above £10,000 net order value, then the customer can specify the delivery date and time. These deliveries will not be chargeable, providing the date and time specified is Monday - Friday between 8am and 5pm.

Connection delivers products on vehicle types most suited to the size and specification of the products being delivered. Where the customer places restrictions on the type and size of vehicle used, additional charges will be applied to the delivery to cover such requests.

Installation

All our deliveries are based on a tailgate service, with unloading to the rear of the vehicle. Connection can, with sufficient notice, offer an installation service. This additional service is chargeable and details of the specific charges can be obtained through our customer services team.

Order Postponement

Connection will not accept postponement of orders below a value of £5,000. Postponement of an order with a value above £5,000 is permitted, but must be requested within a minimum of 10 working days' notice from the advised delivery date. If the postponement of an order is advised to Connection with less than 10 working days' notice from the advised delivery, Connection will raise charges to cover for storage and handling of the products on order. All requests for postponement must be in writing.

Checking the Delivery

All items must be individually counted. Our logistics partner will not accept any signatures marked "UNCHECKED". Please verify the number of items received with the number shown on the delivery document which you are required to sign. You must only sign for the actual number of items received, any discrepancies to the advised quantities must be written on the delivery documentation. Neither our logistics provider nor ourselves will be held responsible for any shortages found after the delivery paperwork has been signed.

Damaged Goods

Any visible damage on delivery must be signed as such on the delivery documentation. If any items should arrive damaged, including water damaged, you must sign the carriers note as "damaged". All damages must be notified to our offices within 48 hours of the delivery. Neither our logistics provider nor ourselves can accept responsibility if we are informed after this time period.

Goods for Collection

Only goods that have been pre-advised for collection will be accepted by our delivery driver. All goods that are to be returned to Connection must be advised to our customer services team 48 hours before the date of your standard delivery.

Returns

No allowances will be made for packing and handling charges on furniture being returned to us. We will accept no merchandise returned to us for credit. If the merchandise is defective and the return is authorised, we will replace or repair the items involved.

Guarantee

Warranty Statement

The company warranties are valid only on standard product for a period of five years; this period may be increased, subject to which products, and will need to be confirmed in writing. The warranty is subject to the following:

A) What Is Covered

When full payment has been received for the goods.

Products used in a single 8-hour shift in an office, or appropriate environment.

Structural and moving parts under fit-for-purpose use and service, and where the product has been used for the purpose it was designed for.

B) What Is Not Covered

Normal wear and tear.

Failure to apply, install, reconfigure or maintain the product in the appropriate way and/or failure to follow Connection's installation instructions.

The product has been used for the purpose which it has been designed and has not be subject to misuse, unauthorised repair, replacement, modification or alteration in any way.

Natural variations in wood grain or the presence of character marks. Changes in surface finishes, including colourfastness due to ageing or due to exposure to light.

Products considered by Connection to be consumables (e.g. batteries, lamps etc.)

Fabric and electrical components (see 2 and 3).

Connection does not warrant products that are exposed to extreme environmental conditions or have been subject to improper storage.

Connection does not warranty any products that have been subjected to incorrect cleaning methods and where the user has not followed the manufacturer's instructions.

Fabric

Fabric quality and performance is not covered by Connection's warranty when specified by our customers or a designer; any claims arising from defective fabric would sit with the manufacturer of the fabric. Connection will facilitate dialogue with the manufacturer and assist in any genuine claim, but in no way accepts liability. However, in the case of COM, the customer will be required to take full responsibility and Connection will not enter into any communication regarding faulty fabric.

Electrical Components

Connection does not cover any electrical components installed in its furniture; any such claim will be directed to the manufacturer.

Connection will facilitate dialogue with the manufacturer and assist in any genuine claim but in no way accepts liability.

All installations of electrical components in Connection products, unless carried out by an approved engineer, will be the responsibility of the customer who will also be responsible for all testing.

Procedure For Making A Warranty Claim

A) UK

In the first instance, contact should be made with our sales office sales@connection.uk.com with a brief outline of the claim. Connection will send out a Non-Conformance form and this need to be completed and returned with appropriate supporting imagery. Connection will respond within two working days, confirming if the claim is acceptable and accompanied with a plan of action which may involve the product being collected by Connection or an engineer visiting site. In both cases this will be carried out during normal working hours and the customer must not impede the process in any way. In the event that the claim is rejected, Connection will provide a suggested plan and costs to rectify any defects.

B) Europe And North America

In the first instance, contact should be made with our sales office sales@connection.uk.com with a brief outline of the claim. Connection will send out a Non-Conformance form and this need to be completed and return with appropriate supporting imagery. Connection will respond within two working days, confirming if the claim is acceptable and accompanied with a plan of action. Connection will supply the components/products to rectify/correct and ship to a warehouse designated by the Customer. The Customer is responsible for any duty and the installation of the new components/products and disposal of any unwanted items.

Where sales are transacted on an ex-factory basis, the Customer accepts that the product has left the factory in good condition and any subsequent claims will not be considered by Connection.

Damages

Any product damaged on delivery must be signed as such on the delivery documentation. If any items should arrive damaged, including water damage, you must sign the carrier's note as "damaged". All damages must be notified to our offices within 48 hours of the delivery. Neither our logistics providers nor ourselves can accept responsibility if we are informed after this time period.

CSR, Sustainability & the Environment

In all our core business operations, our aim is to ensure we act ethically and responsibly by adopting best practice within our **Corporate Social Responsibility (CSR)** policy and this is embedded into all our practices to the benefit of all our stakeholders.

We consider these stakeholders to be our employees, shareholders, customers, suppliers and the communities within which we operate.

We are committed to the following core values:

- **To address the needs and aspirations of our employees, whilst considering their health, safety and promoting a good work/life balance**
- **To minimise the environmental impact of our operations and enhance the sustainability of our products**
- **To adopt a good relations strategy with our customers and strive to achieve agreed standards of safety and quality**
- **To ensure we are honest and fair in all our dealings with our suppliers and aim to procure all our goods and services in an ethical manner**
- **To support our communities by being sensitive to their needs, responsible in our operations and through the adoption of charitable causes**

Product Information

We consider the impact upon the environment throughout all of our processes, from the initial design of the product, through its manufacture and delivery, right up to disposal when it has reached the end of its useful life. We calculate and hold data on all our products, detailing use of recycled content and recyclability. This information is compliant with the SKA rating criteria.

Carbon Balanced Printing

Carbon balanced paper is a simple way to reduce the impacts of carbon in the environment. This is where the average carbon impact for paper has been balanced or offset by the World Land Trust, through the preservation of high conservation forests, saving threatened habitats and their biodiversity.

All of our printed materials as a business are now carbon balanced.



Export Information

Connection is a UK based company, with a brand that has developed overseas. On our website there is a French, German and The Americas section, where you can find details of our representatives in these countries. Additional representatives outside of the UK can be found on our contact page.

Here are brief guidelines on ordering for export:

- All goods are exempt from UK VAT
- The customer is responsible for all import tax duties unless agreed in writing by Connection
- Payment terms are net 30 days from date of invoice. Standard export terms are pro forma payment prior to despatch unless otherwise agreed to by Connection in writing
- Our ordering processes and acknowledgements are standard for exported goods and UK goods
- Prices will be quoted in Sterling, Dollars or Euros and are based on ex factory unless otherwise agreed by Connection in writing

Delivery

Connection utilise state of the art logistic systems to facilitate deliveries to our customer's premises.

Our customer services team will advise of an estimated time of arrival once the goods have been collected from Connection for shipment. A confirmed delivery date can only be given once all local import duties have been paid.

Delivery to EU Countries

Connection predominately offer ex works pricing on all export orders, however where required we can facilitate the arrangement of transport. Where a customer's delivery is required to be arranged by Connection, the following charges are applicable.

Small Order Charges

For a customer warehouse delivery, where the net order value is below £1500, a charge of £150 will be applied.

Standard Order Delivery Charges

Where requested, Connection can arrange deliveries direct to site. Prices for these are specific to a customer request, and as such will be priced on application. Connection cannot arrange installation for any Export deliveries, this needs to be arranged locally by the customer.

Order Postponement

Where a customer advises Connection of a postponement of an order giving a minimum of one weeks notice from the scheduled collection/delivery, no charge will be made providing the order is rescheduled for collection/delivery.

If the postponement of an order is advised to Connection with less than one weeks notice, Connection will raise charges to cover for storage and handling of the products on order. All requests for postponement must be in writing.

Connection package products for export customers based on them being loaded directly onto a designated container. Where the product is to be shipped through a groupage network, then Connection have designed and developed additional "sea worthy" packaging which is strongly recommended to be used on all such shipments. This packaging does have an additional charge applied to the shipment, details of which can be obtained through our customer services team. If customers do not request this additional packaging for groupage items as recommended, then Connection cannot be held responsible for any damages caused through the transportation of the product.

Export Contact

Patricia Theaker

T: +44 (0)1484 600112







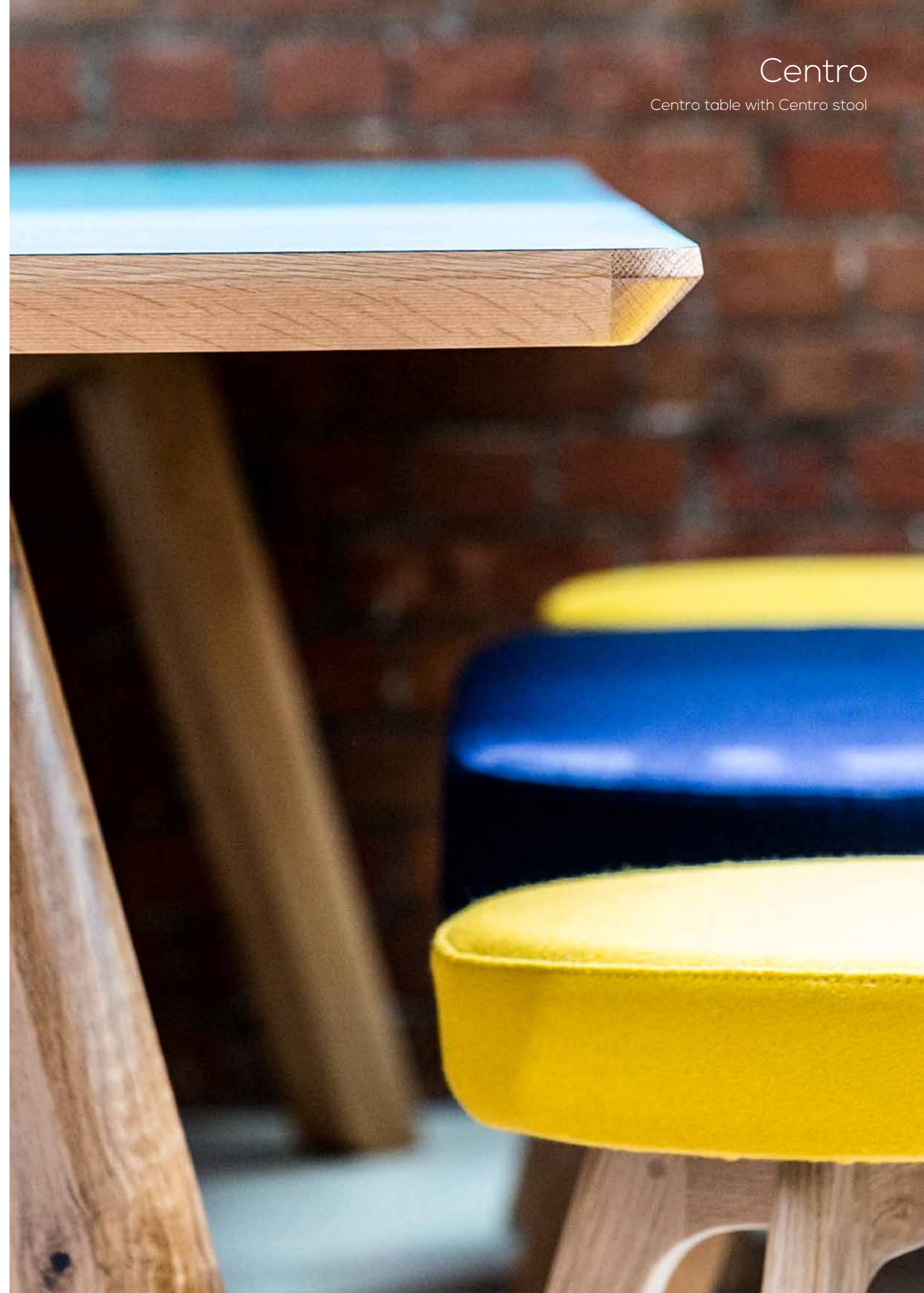























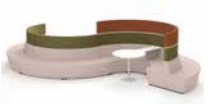

E: patricia.theaker@connection.uk.com

Centro































Centro table with Centro stool



A-Z Index

Ark pg 82		Assemble pg 188		Beam pg 124	
Canova pg 166		Centro Stools & Benches pg 174		Centro Chairs pg 166	
Centro Lite pg 121		Centro Tables pg 117		Centro Rustic pg 120	
Check pg 97		Check Tables pg 146		Compito pg 192	
Co.Table pg 129		Connect pg 140		Crux pg 41	
Cubbi pg 63		Cubix pg 184		Dixi pg 76	
Dixi Tables pg 142		Flock pg 50		Flow pg 148	
Fusion pg 150		Gloss pg 143		Gravity pg 194	
Hive pg 55		Horizon pg 112		Hygge pg 70	
Is pg 195		Kala pg 83		Korus pg 90	
Laurel pg 164		Leo pg 100		Leo Tables pg 146	

A-Z Index

Luna pg 162		Mae pg 79		Mortimer pg 102	
Mortimer Tables pg 146		Muse pg 74		Muzia pg 190	
My pg 196		Nomad pg 44		Omni pg 142	
Pear pg 86		Peacework pg 61		Platforms pg 15	
Platforms Accessories pg 25		Platforms Additions pg 19		Platforms Box pg 182	
Report pg 198		Rollie pg 87		Rooms pg 8	
Session pg 160		Soloscape pg 46		Swoosh Chairs pg 93	
Swoosh Sofas pg 110		Swoosh Stools pg 180		Tier pg 29	
Tryst Booths pg 35		Tryst Sofas & Armchairs pg 105		Tubes Chairs pg 167	
Tubes Stools & Benches pg 176		Tubes Tables pg 135		Xpresso pg 153	

Head Office & Showroom

Dogley Mills,
Penistone Road,
Huddersfield,
West Yorkshire,
HD8 0LE

T: 01484 600 100
enquiries@connection.uk.com

London Showroom

31 Great Sutton Street,
Clerkenwell,
London,
EC1V 0NA

T: 020 7253 9877

Manchester Showroom

The Old Law Library,
14 Kennedy Street,
Manchester,
M2 4BY

T: 01484 600 100